



## Before You Begin

READ THESE INSTRUCTIONS COMPLETELY AND CAREFULLY



## Installation And Operation Instructions

### For FHSCP-UNV Series Emergency LED Drivers

Models: FHSCP-UNV-5WL, FHSCP-UNV-7.8WL, FHSCP-UNV-10.7WL, FHSCP-UNV-13.7WL, FHSCP-UNV-17WL, FHSCPUNV5WL-CEC, FHSCPUNV7.8WL-CEC, FHSCPUNV10.7WL-CEC, FHSCPUNV13.7WL-CEC, FHSCPUNV17WL-CEC

### IMPORTANT SAFEGUARDS

When using electrical equipment, basic safety precautions should always be followed, including the following:

#### READ AND FOLLOW ALL SAFETY INSTRUCTIONS:

- 1) The FHSCP-UNV is designed for factory installation and for field installation only if determined to meet the as installed egress requirements as outlined on page 4 of these instructions.
- 2) Installation should be performed by qualified personnel only.
- 3) Install in accordance with the National Electric Code and applicable local codes.
- 4) The FHSCP-UNV requires an unswitched AC power source of 120 to 277 volts, 50/60 HZ.
- 5) The FHSCP-UNV is suitable for use in dry and damp location where ambient temperature is 0 to 50C.
- 6) The FHSCP-UNV should be mounted in locations and at heights where it will not readily be subjected to tampering by unauthorized personnel.
- 7) The FHSCP-UNV is suitable for use only with LED lamps having an operating voltage of 20Vdc minimum, 50Vdc maximum and will provide 90 minutes of emergency operation.
- 8) To reduce the risk of electrical shock, do not connect FHSCP-UNV converter connector until installation is complete and AC power is applied to the luminaire.
- 9) The FHSCP-UNV has more than one power source. To reduce the risk of electrical shock, remove the normal AC power source(s) to the luminaire and disconnect the FHSCP-UNV converter connector before servicing.
- 10) The use of accessory equipment not recommended by the manufacturer may cause an unsafe condition and will void warranty.
- 11) Do not use this equipment for other than intended use.
- 12) Do not mount near gas or electric heaters.
- 13) Servicing of this equipment should be performed by qualified personnel only.
- 14) The FHSCP-UNV is a sealed unit. Components are not replaceable. Replace entire unit when necessary.
- 15) The FHSCP-UNV contains a non-replaceable NiCd battery that must be recycled properly.

### SAVE THESE IMPORTANT SAFETY INSTRUCTIONS

The installation and use of this product must comply with all national, federal, state, municipal, or local codes that apply. Please read this manual thoroughly before installing or operating FHSCP-UNV Emergency LED Drivers.

# Installation Instructions

**CAUTION:** Before installing, make certain the AC power is off and the FHSCP-UNV converter connector is disconnected.

## 1. MOUNTING THE EMERGENCY LED DRIVER (FHSCP-UNV)

Mount FHSCP-UNV to the top of the luminaire with suitable fasteners (not provided). Drill or punch a 7/8" hole (1/2" knockout) on top of luminaire for flexible conduit. Attach flexible conduit to luminaire. (Refer to Figure 1)

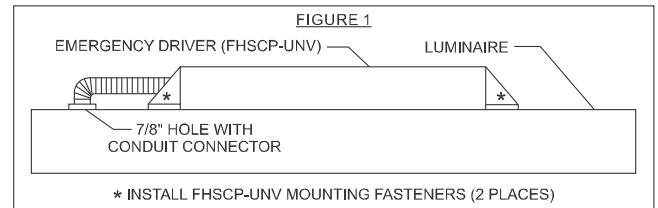

## 2. WIRING THE FHSCP-UNV

Perform all wiring with exception of the Violet and Brown wires.

Note: wiring must be performed in accordance with the National Electric Code and applicable local codes. Consult Customer Service for additional wiring diagrams. (Refer to Figure 2)

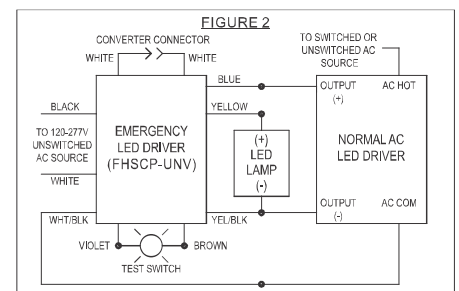

## 3. INSTALLING THE LED COMBO TEST SWITCH (LCTS)

Recessed Troffer Luminaire – Select a convenient location with proper clearance in the LED Driver cover and drill or punch a 7/8" hole (1/2" knockout). Insert the 7/8" bushing into the hole. Push the plastic tube through the bushing. Route the leads of the LCTS through the plastic tube. Connect the wires from the FHSCP-UNV to the LCTS (Violet to Violet, Brown to Brown). (Refer to Figure 3)

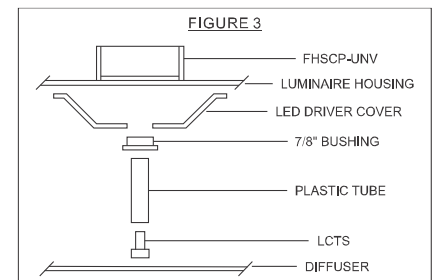

Strip Luminaire – Select a convenient location on the fixture where the LCTS will be visible after installation. Allow for proper clearance inside the fixture and drill or punch a 1/2" hole. Push the LCTS housing into the 1/2" hole and secure with nut. Connect the wires from the FHSCP-UNV to the LCTS (Violet to Violet, Brown to Brown). (Refer to Figure 4)

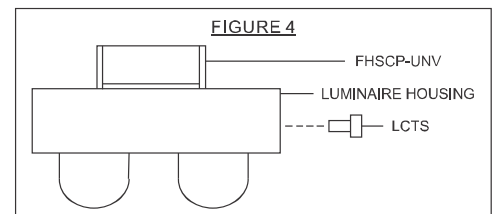

## 4. WIRING THE AC INPUT

- The FHSCP-UNV and AC LED Driver must be on the same branch circuit.
- The FHSCP-UNV requires an unswitched AC power source of 120 to 277 volts.
- When the FHSCP-UNV is used in a switched luminaire, the AC input to the FHSCP-UNV must be connected to ahead of the luminaire switch (line side of luminaire switch). (Refer to Figure 2)

## 5. COMPLETING INSTALLATION

When the installation is complete, switch the AC power ON and join the FHSCP-UNV converter connector.  
(Refer to Figure 2)

## OPERATION

**Normal Mode** – AC power is present. The AC LED Driver operates the LED lamp(s) as intended. The LCTS will be illuminated indicating that the FHSCP-UNV is in the standby charging mode.

**Emergency Mode** – AC power fails. The FHSCP-UNV senses the AC power failure and automatically switches to Emergency Mode. One or multiple LED lamps will be illuminated for a minimum of 90 minutes. When AC power is restored, the FHSCP-UNV switches the system back to the Normal Mode and resumes battery charging.

## TESTING AND MAINTENANCE

Pressing the LCTS simulates an AC power failure and forces the system into the Emergency Mode. Only the emergency LED lamp (s) will be illuminated. Testing may also be performed by opening circuit breaker powering the system.

**Initial Testing** – Allow the unit to charge for approximately 1 hour, then press the LCTS to conduct a short test. Allow a 24 hour charge before conducting a 1 ½ hour test.

**Monthly** – Insure that the LCTS is illuminated. Conduct a 30 second test by depressing the LCTS

**Annually** – Insure that the LCTS is illuminated. Conduct a 1 ½ hour test by opening circuit breakercontrolling the FHSCP-UNV unit(s) to be tested.

“Written records of testing shall be kept on file for inspection by the authority having jurisdiction.”

## 6. INSTALLATION DIAGRAMS

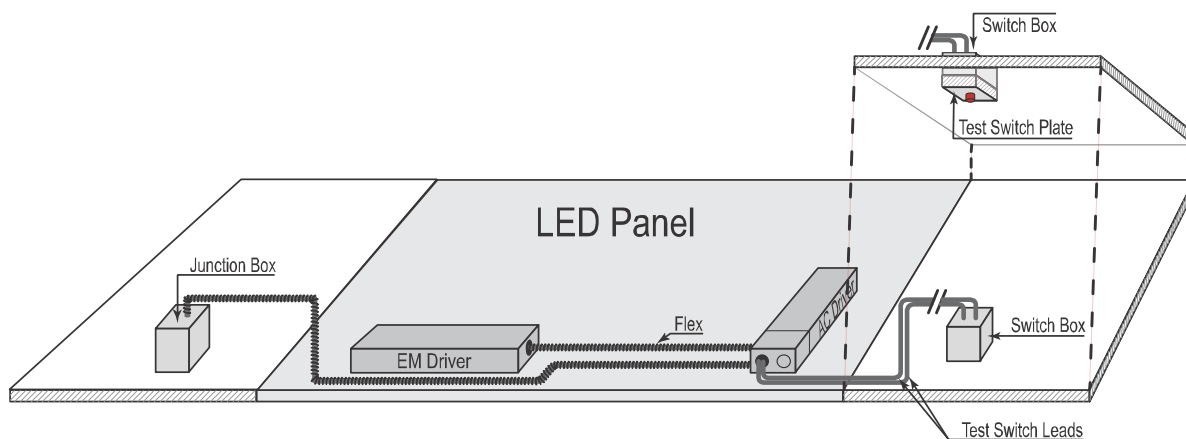

### Test Switch Leads

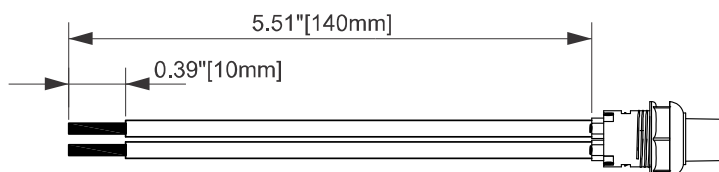

**Note:** When remote mounting the test button use compliant wire (for example UL CL2 plenum rated wire) or conduit, depending on local code for low voltage signal wiring. Mount no further than 5ft.

# FHSCP-UNV Series System Coordination Guidelines

These guidelines were developed to allow the lighting system Designer/Specifier to predict the operating performance levels of LED luminaires when powered by an electrically compatible FHSCP-UNV Series model. It is ultimately the responsibility of the Designer/Specifier to ensure that the as installed system delivers code-compliant path of egress illumination.

## 1) Determine Electrical Compatibility

- A) Verify that the Luminaire LED Driver, where applicable, is Class 2 compliant.
- B) Verify that the Luminaire LED Lamp(s) have an operating voltage between 20Vdc and 50Vdc.
- C) Verify that the Luminaire LED Lamp(s) have a power rating equal to, or greater than, the emergency power rating of the FHSCP-UNV model under consideration.

(Refer to Table 1)

TABLE 1

FHSCP-UNV MODEL	EMERGENCY OUTPUT (CONSTANT)
FHSCP-UNV-5WL, FHSCPUNV5WL-CEC	5.0 WATTS
FHSCP-UNV-7.8WL, FHSCPUNV7.8WL-CEC	7.8 WATTS
FHSCP-UNV-10.7WL, FHSCPUNV10.7WL-CEC	10.7 WATTS
FHSCP-UNV-13.7WL, FHSCPUNV13.7WL-CEC	13.7 WATTS
FHSCP-UNV-17WL, FHSCPUNV17WL-CEC	17.0 WATTS

## 2) Calculate Lumen Output During Emergency Operation

- A) Access luminaire data by logging onto Design Lites Consortium ([www.designlights.org](http://www.designlights.org)).
- B) Select “Search the DLC Qualified Product List” on the DLC homepage.
- C) Enter manufacture name and P/N of luminaire under consideration in the “search by keyword” text window.
- D) Select “Search” tab to open the “Qualified Products List”.
- E) Determine luminaire Lumens per Watt efficacy in “Rated Data” specifications.
- F) Multiply luminaire Lumens per Watt by Emergency Output of the FHSCP-UNV model under consideration.

(Refer to Table 1)

This figure is the Lumens available from the luminaire during emergency operation.

## 3) Determine Suitability of Means of Egress Lighting Levels

- A) Using industry standard lighting design software, along with IES files for the luminaire under consideration, verify that the as installed available Lumens (as calculated in 2F above) are sufficient to meet Code-compliant path of egress illumination levels.

**While the FHSCP-UNV series has been found compliant with the requirements of UL Standard 924, it is ultimately the responsibility of the Designer/Specifier to assure the as-installed system delivers code-compliant path of egress illumination in accordance with Federal, State or local municipal requirements.**

# FHSCP-UNV Detailed Wiring Diagram

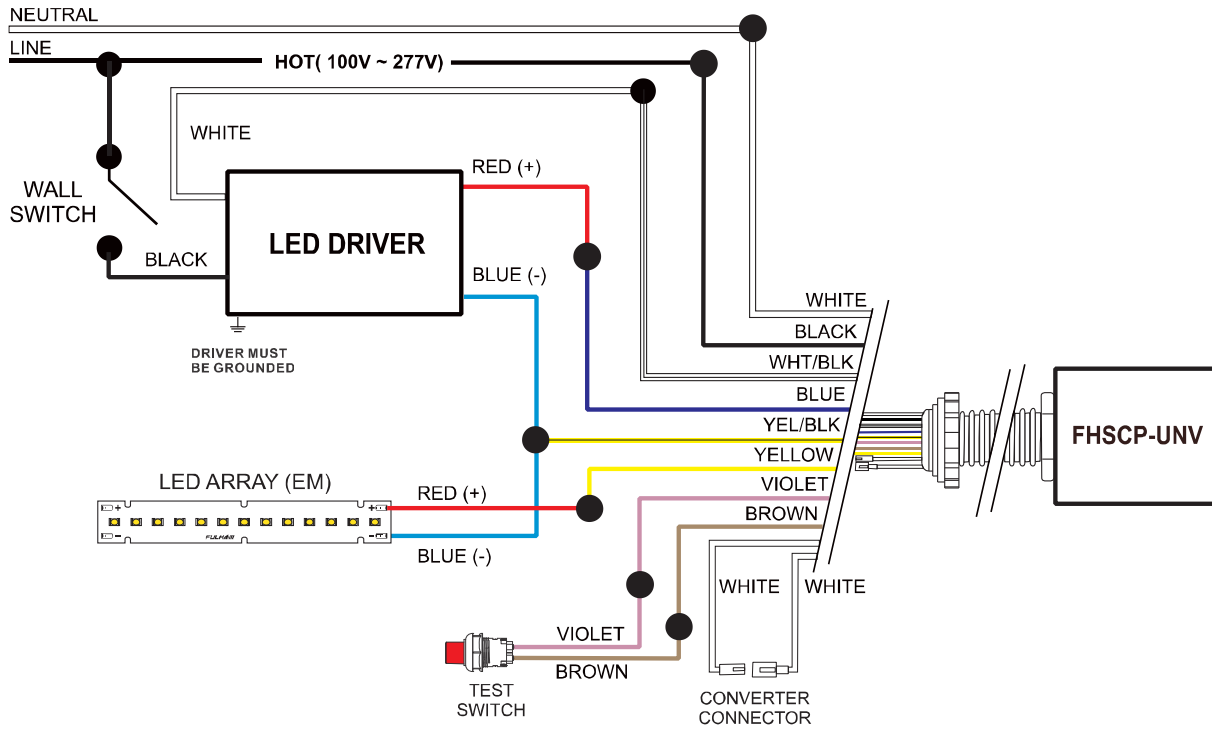

**(800) 451-2606**  
7905 Cochran Road, Suite 300  
Glenwillow, Ohio 44139 USA  
E-mail: [Venture\\_Lighting@VentureLighting.com](mailto:Venture_Lighting@VentureLighting.com)  
**VentureLighting.com**

