



## Description

Venture Lighting's Modern High Bay luminaires are low profile, durable, and designed for long life and low maintenance. They are designed to upgrade quickly and easily existing H.I.D. and fluorescent fixtures.

## Construction

The high-performance LED source is mounted to an aluminum heat sink which is designed to ensure proper thermal management of the system. This design allows for a cooler running LED chip which leads to longer lifetime, better efficacy, and color consistency. Fixtures are rated for an ambient operating temperature range -30°C to 50°C. Modern high bay luminaires are water and dust resistant, with IP65 rating.

## Optics

The 200W units are equipped with a 90-degree beam spread for higher mounting heights and are also field adjustable with an accessory lens.

## Electrical

The power supply has a range of 277V-480V, 50/60 Hz. 0-10V DC dimming capability is standard. The luminaire is rated for damp and dry locations.

## Application Notes

Can be used for natatorium applications.

## Warranty

For warranty information refer to: [www.venturelighting.com/resources/warranties](http://www.venturelighting.com/resources/warranties)

## Notes

\* Lumen maintenance data is based on LED testing per IES LM-80 and projected per IES TM-21

## Product Performance

Wattage	200W
Lumens	25400
Correlated Color Temperature (CCT)	5000K
Color Rendering Index (CRI)	80
Lumen Maintenance @50,000 Hours*	92%
Calculated L70 @25°C Ambient (Hrs)*	223,000
Replaces HID Wattage	750W
Spacing Criterion (0-180)	1.3 x mtg height
Spacing Criterion (90-270)	1.3 x mtg height
Beam Angle (°)	90°
Operating Temperature Range	-22°F to 122°F (-30°C to 50°C)

## Physical Characteristics

Input Cable Length	5ft.
Safety Cable Length	3ft.
Fixture Color	White
Length	15.1" dia.
Height	10.2"
Weight	18.3 lbs

## Electrical Characteristics

Amperage Draw (Input Volts/Amps)	277/1.0 347/0.58 480/0.43
Surge Protection	4kV

## Regulatory Qualifications

cULus Listed

## Accessories

AC26864 – Adjustable Bracket Kit, White 300W (120-277V), 100-200W (277-480V)

AC53904 – Pendant Mount Kit 300W (100-277V), 100-200W (277-480V)

LN13632 – 120 Degree Plastic Flat Lens for 100W to 300W High Bay

LN13492 – Frosted Polycarbonate Lens for 100W to 300W High Bay

LN28431 – 50 Degree Lens for 100W to 200W High Bay

LN13421 – 120 Degree Clear Tempered Glass Flat Lens

RF13912 – 16.5" Dia. Acrylic Reflector for 100W to 300W High Bay

RF13388 – 15.3" Dia. Alum. Shield for 100W to 300W High Bay (silver)

Add suffix "-S1" for a factory installed Motion Only Sensor (PH48156)

Add suffix "-S2" for a factory installed Motion/Dim/Photocell Sensor (PH52321)

Add suffix "-S3" for a factory installed Wet & Low Temp. Rated Motion Only Sensor (PH36512)

Add suffix "-S4" for a factory installed Wet & Low Temp Rated Motion/Dim/Photocell Sensor (PH37415)

For factory installed plug options see below

For plug options see accessories tab (NOT FACTORY INSTALLED)

Revision: 07, 01-Jul 2021



# Venture 200W LED High Bay Fixture

## Dimensions

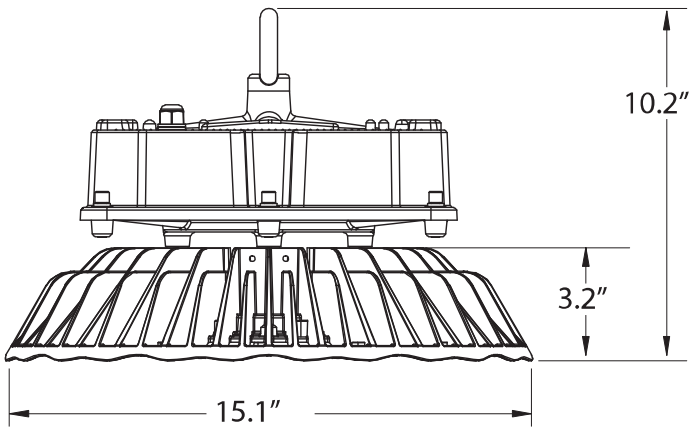

## Luminous Intensity Distribution Diagram

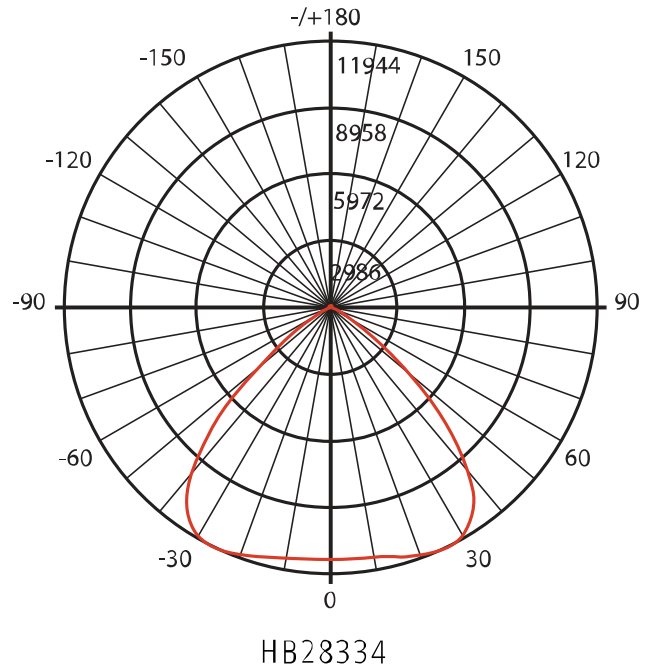

RF13912

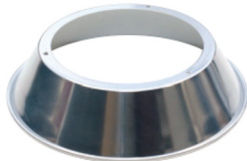

RF13388



LN13632



LN28431



S1/S2 Factory Installed Sensor



NEMA L24-20P

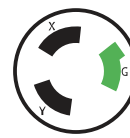

NEMA L8-20P

Plug Options*	Molded Plug Options with 11ft Cable*
"-P4" – NEMA P8-20P for 480V	"-P9-C" – NEMA P8-20P for 480V w/ cable
"-P14" – NEMA P24-20P for 347V	"-P15-C" – NEMA P24-20P for 347V w/ cable

NOTE: \* Add Suffix to Part# for Factory Installed option

**(800) 451-2606**

7905 Cochran Road, Suite 300

Glenwillow, Ohio 44139 USA

Email: [Venture\\_Lighting@VentureLighting.com](mailto:Venture_Lighting@VentureLighting.com)

**VentureLighting.com**

