



Description

Experience better tennis lighting, with less glare. Venture Lighting has combined LED efficiency with specialty optics to create proper light levels in the right places of any tennis court. Venture's CrossCourt system requires no tilting and as such is glare-free, Dark-Sky, and neighborhood friendly. Eliminate the need to tilt the fixture and brighten the playing field. Venture's CrossCourt wins match, set - game over.

- Superior spill light control
- Ability to illuminate individual courts when the entire complex is not in use
- Lower visual impact on the surrounding environment
- Reduced glare; Perfect for lower poles

Construction

Rugged die cast housing finished in a durable powder coat finish and with vandal resistant polycarbonate lens. To ensure weather-tight protection, each optical assembly is sealed with a silicone gasket. Luminaires are rated for an ambient operating temperature range of -40°C to 40°C.

Electrical

The Class I power supply has a range of 347-480V, 50/60 Hz (a 120-277V input version is also available). LED driver is isolated from the LED light engine for enhanced driver reliability. 0-10V DC dimming capability is standard. The luminaires are rated for wet locations. Each fixture has a built-in 10kA surge protector. Each fixture is supplied with a 7-pin receptacle and a shorting cap. A motion sensor can be factory installed. Twistlock photocell accessory can easily be mounted onto the fixture.

Mounting

The fixture is designed for use with various mounting accessories: Square and round pole arms, slipfitter or mast arm. The slipfitter and the mast arm fit a 2-3/8" tenon. All mounting accessories are ordered separately and field installed.

Notes:

*Lumen maintenance data is based on LED testing per IESNA LM-80 and projected per IESNA TM-21

Product Performance

Wattage	120W
Lumens	12900
Correlated Color Temperature (CCT)	5000K
Color Rendering Index (CRI)	70+
Lumen Maintenance @50,000 hours*	99%
Calculated L70 @ 25°C Ambient in Hours*	>500,000
Distribution	Tennis Court Lighting
Replaces HID Wattage	175W V, 250W H
Operating Temperature Range	-40°F to 104°F (-40°C to 40°C)

Physical Characteristics

Fixture Color	Bronze
EPA	0.67
Length	17.5"
Width	10.25"
Height	6.01"
Weight	13.9 lbs (6.3kg)

Electrical Characteristics

Input Voltage Range	347-480V
Amperage Draw (Input Volts/Amps)	347/0.36 480/0.26
Surge Protection	10kA

Regulatory Qualifications

cULus Listed, Rated for wet locations

Accessories

EN14178 Round pole straight arm - bronze

EN26814 Square pole mount - bronze

EN35512 Adjustable slipfitter - bronze

EN38419 Mast arm - bronze

EN47832 Wall mount - bronze

PH87145 3-Pin Twist lock photocell (347V)

PH81156 3-Pin Twist lock photocell (480V)

PH81975 Replacement shorting cap

Add suffix "-M34" to order code for a factory installed fixture with Motion/Dim/Photocell Sensor

Add suffix "-SH" to order code for a factory installed fixture with backlight shield

Add suffix "-SHM34" to order code for a factory installed fixture with backlight shield & Motion/Dim/Photocell sensor

SP12714 – 120-277V Surge Protector



Venture CrossCourt 120W LED Tennis Lighting

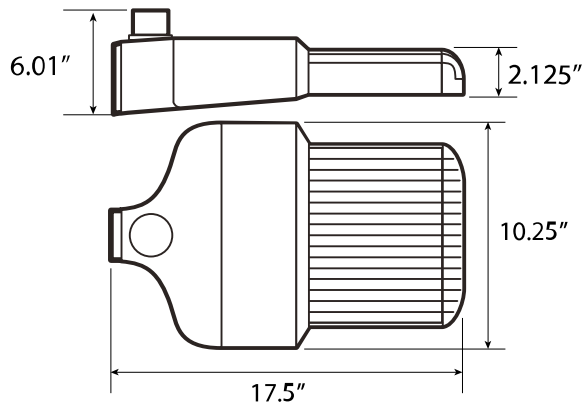

120W

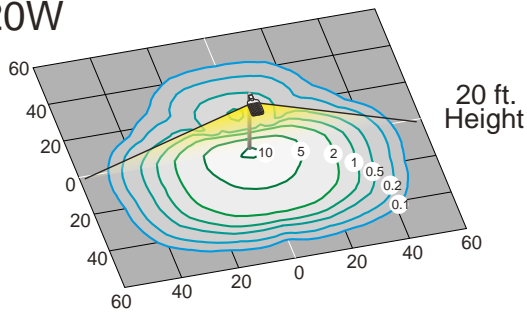

PH12415



EN26814



EN38419



PH81975



EN14178



EN35512



SP12714



EN47832

Accessories

Wattage	B-U-G Rating
120W	B3-U0-G1
150W	B3-U0-G2
200W	B3-U0-G2

(800) 451-2606
 Fax: (800) 451-2605
 7905 Cochran Rd, Suite 300
 Glenwillow, Ohio 44139
 E-mail: Venture_Lighting@VentureLighting.com
VentureLighting.com

