



Description

Venture Lighting's parking garage luminaires are low profile, lightweight, and designed for long life with low maintenance and great performance. These LED luminaires are designed to quickly and easily upgrade existing HID parking garage fixtures.

Construction

Rugged die cast aluminum housing finished in a durable powder coat finish and with polycarbonate lens. The high-performance LED sources are mounted to ensure proper thermal management of the system. The design allows for a cooler running LED chip which leads to longer lifetime, better efficacy, and color consistency. The fixture is gasket sealed to eliminate the threat of contaminants damaging the components. The standard fixture color is bronze, custom colors available upon request.

Electrical

The power supply has a range of 120-277V, 50/60 Hz. The luminaires are rated for wet locations. 0-10V DC dimming and 10kA surge protection is standard. An internally mounted motion/dimming/photocell sensor can be installed as an option.

Mounting

Cast in knock-out template for ceiling/surface mounting to a junction box. Fixtures are compatible for 1/2" NPT surface mount conduit applications. Screw plugs can be removed for surface mounted conduit applications. Fixtures also are capable of being pendant mounted (50W/84W 3/4" NPT & 44W 1/2" NPT) with no additional mounting accessories needed.

Warranty

For warranty information refer to: www.venturelighting.com/resources/warranties

Notes

*Lumen maintenance data is based on LED testing per IESNA LM-80 and projected per IESNA TM-21

Product Performance

Wattage	50W
Lumens	5000
Correlated Color Temperature (CCT)	5000K
Color Rendering Index (CRI)	75+
Lumen Maintenance @50,000 hours*	87%
Calculated L70 @ 25°C Ambient in Hours*	>129,000
Integrated Sensor Included	Optional
Replaces HID Wattage	Up to 175W
Operating Temperature Range	-40°F to 104°F (-40°C to 40°C)

Physical Characteristics

Fixture Color	Bronze
Length	15.0"
Width	15.0"
Height	4.8"
Weight	21 lbs

Electrical Characteristics

Input Voltage	120-277V; 60Hz
Amperage Draw (Input Volts/Amps)	120/0.71 208/0.42 240/0.37 277/0.32
Power Factor	≥90%
THD	≤20%
Dimming	0-10V DC Continuous to 10%

Regulatory Qualifications

cULus Listed
 BAA/TAA, available upon request

Accessories

AC57163 – 1/2" Flex Conduit Extender
 BB24624 – LED Fixture Battery Backup
 PH43982 – Wireless BLE Motion/Dim/Photocell Sensor
 PH18673 – Sensor Lens for Garage (low mounting height) Applications
 SP12714 – 120-277V Surge Protector
 Add suffix "-M12" for a factory installed Motion/Dim/Photocell Sensor

Note: AC57163 is required when installing BB24624 with CP46158 (50W Safelit Garage Fixt.)

Revision: 03, 22-Nov 2022



Venture 50W Safelit LED Parking Garage Fixture

Dimensions

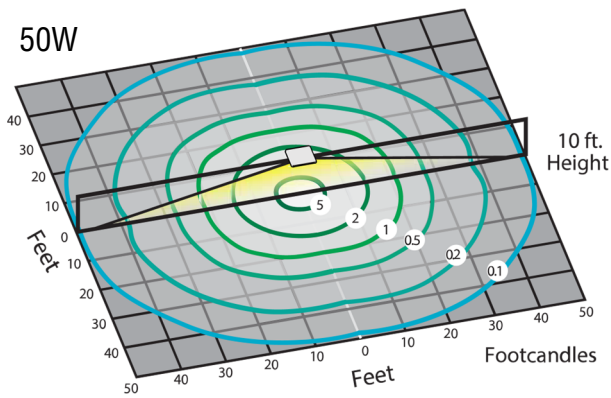
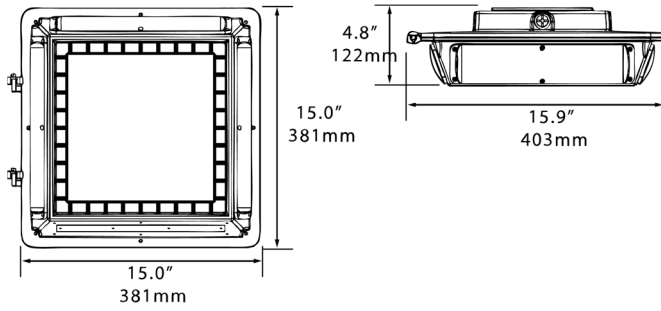

BUG Rating B3-U4-G4

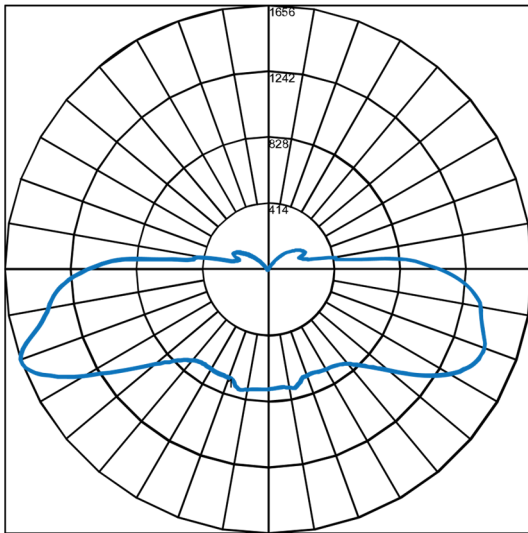

Maximum Candela = 1655.9 Located At Horizontal Angle = 135, Vertical Angle = 69
1 - Vertical Plane Through Horizontal Angles (135 - 315) (Through Max. Cd.)

(800) 451-2606

6675 Parkland Blvd., Suite 100

Solon, Ohio 44139 USA

Email: Venture_Lighting@VentureLighting.com

VentureLighting.com

