



IGNITOR SPECIFICATION

Part Number: BVS-006-REPL
BMS-006-REPL

35-150W HPS IMP Ignitor with Quick Connect & Harness



Maximum Case Temperature:	105°C
Peak Voltage:	2500-4000
Case Height:	2.61 IN
Case Diameter:	1.25 IN
Case Width:	0.93 IN

Refer to the applicable ballast spec for the wiring diagram and ballast to lamp (BTL) mounting distance.

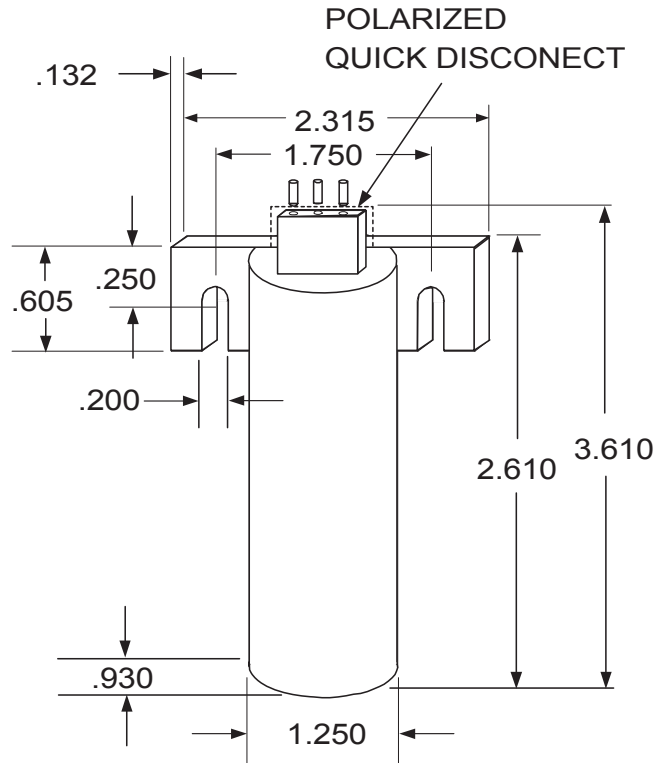

Data is based upon tests performed by Venture Lighting in a controlled environment and is representative of relative performance. Actual performance can vary depending on operating conditions. Specifications are subject to change without notice.