



## Before You Begin

Read These Instructions Completely and Carefully



## UNPACKING

- Unpack and carefully examine the product.
- Report any damage and save all packing materials if any part(s) were damaged during shipping.
- Do not attempt to install or use this equipment if it is damaged.

## INCLUDED IN THIS BOX

- LED fixture with U-bracket attached.
- Installation instructions.

## **WARNING – RISK OF FIRE, ELECTRIC SHOCK, INJURY, OR PROPERTY DAMAGE**

- Failure to follow these instructions or altering equipment could result in injury or damage and void warranty. Venture assumes no liability for injury, damages or losses of any kind that may arise from the improper, careless, or negligent installation, handling or use of this product.
- This equipment must be installed and serviced per applicable codes and ordinances by qualified personnel (ex. licensed electrician) familiar with the operation of the product and any hazards involved.
- Disconnect power to the equipment and allow to cool before installing or servicing.
- Handle sharp edges with care. To prevent wiring damage, do not expose wiring to sharp edges.
- Verify that all electrical connections have been properly made and the fixture is grounded to avoid potential electrical shocks.
- It is the installers responsibility to confirm the proper input voltage is used with the equipment.
- Do not handle energized equipment when hands are wet, when standing on wet surfaces, or in water.
- This fixture must be mounted securely to a structure to support the weight.

## SUPPLIER'S DECLARATION OF CONFORMITY (SDoC)

- This equipment complies with the limits for a Class A digital device, pursuant to Part 15 Subpart B of the FCC Rules. These limits are designed to provide reasonable protection against harmful interference when the equipment is operated in a commercial, industrial or business environment.

For warranty information refer to <https://www.venturelighting.com/resources/warranties.html>.

## IMPORTANT SAFETY INFORMATION

- Operating temperature: -40°C to +50°C (-40°F to 122°F).
- Suitable for use in wet locations.
- All wiring and connectors used with this equipment shall be rated a minimum of 90°C (194°F)

## Installation Instructions – U-Bracket

- 1: Disconnect power from the luminaire and follow proper lockout/tagout procedures before beginning installation or maintenance.
- 2: Remove the existing luminaire (if present) and dispose of per local requirements.
- 3: Remove clear knockout from back of fixture to gain access to dip switches. Dip switches are used to change wattage, color temperature, and to enable/disable photocell. (Figure 1)
- 4: Adjust dip switch position for desired setting. (Figure 2)
- 5: Reinstall clear knockout cover from Step 3.
- 6: Mount fixture to appropriate surface using proper hardware (supplied by others).
- 7: Connect the supply wires to junction box, or similar, as shown in wiring diagram below.  
**NOTE:** The correct polarity of the dimming connections is essential to proper operation.  
**NOTE:** If not using the dimming functionality, insulate the Dim(+) (purple) and Dim(-) (gray) wires separately (bare wires should not be left exposed). **DO NOT** connect the Driver Dim(+) (purple) to the Driver Dim(-) (gray) wire as the fixture will not operate correctly.
- 8: Loosen (2) angle adjustment screws on both sides of fixture. (5mm) (Figure 3)
- 9: Set fixture to proper angle then retighten the angle adjustment screws.
- 10: Power can now be restored to the system.

## Installation Instructions – Adjustable Slipfitter

- 1: Follow Steps 1 through 5 in above U-bracket installation instructions.
- 2: Remove U-bracket by removing 2 angle adjustment screws from both sides of fixture. (5mm)
- 3: Fish cable through flat mounting arm. (Figure 7)  
**NOTE:** Hole for wire should be oriented so it is offset to left and toward top of bracket.
- 4: Fish cable through rubber grommet.
- 5: Remove angle adjustment screw from Adjustable Slipfitter Arm. (8mm) (Figure 4)
- 6: Fish wire through first half of arm.
- 7: Screw first half of arm to fixture using supplied hardware. (6mm) (Figure 5)
- 8: Fish wire through second half of arm.
- 9: Reconnect arm using the angle adjustment screw. Do not completely tighten.
- 10: Adjust arm to desired angle then finish tightening angle adjustment screw. (Figure 6)
- 11: Connect the supply wires as shown in the wiring diagram below.  
**NOTE:** The correct polarity of the dimming connections is essential to proper operation.  
**NOTE:** If not using the dimming functionality, insulate the Dim(+) (purple) and Dim(-) (gray) wires separately (bare wires should not be left exposed). **DO NOT** connect the Driver Dim(+) (purple) to the Driver Dim(-) (gray) wire as the fixture will not operate correctly
- 12: Loosen set screws on arm and slide fixture and arm over 2-3/8" OD tenon. (6mm)
- 13: Tighten set screws and restore power to the system.

## Installation Instructions – Knuckle Mount

- 1: Follow Steps 1 through 5 in above U-bracket installation instructions.
- 2: Remove U-bracket by removing 2 angle adjustment screws from both sides of fixture. (5mm)
- 3: Fish cable through mounting plate. (Figure 7)
- 4: Fish cable through rubber grommet.
- 5: Remove angle adjustment screw from Knuckle Mount Arm.
- 6: Fish wire through first half of arm. (Figure 8)
- 7: Screw first half of arm to fixture using supplied hardware. (Figure 8)
- 8: Fish wire through second half of arm.
- 9: Reconnect arm using the angle adjustment screw. Do not completely tighten.
- 10: Adjust arm to desired angle then finish tightening angle adjustment screw.
- 11: Attach fixture to junction box, or similar, using supplied nut.

**12:** Connect the supply wires as shown in the wiring diagram below.

**NOTE:** The correct polarity of the dimming connections is essential to proper operation.

**NOTE:** If not using the dimming functionality, insulate the Dim(+) (purple) and Dim(-) (gray) wires separately (bare wires should not be left exposed). **DO NOT** connect the Driver Dim(+) (purple) to the Driver Dim(-) (gray) wire as the fixture will not operate correctly

**13:** Close junction box, or similar, and restore power to the system.

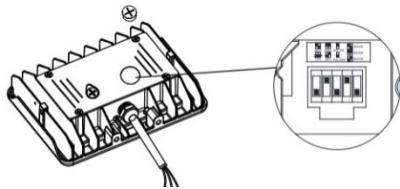

**Figure 1**

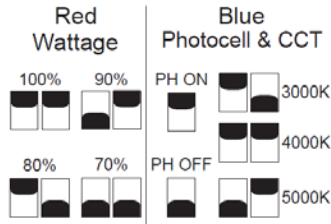

**Figure 2**

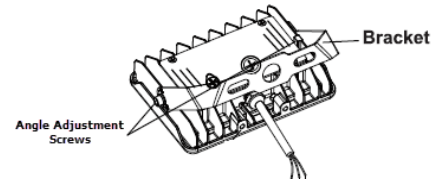

**Figure 3**

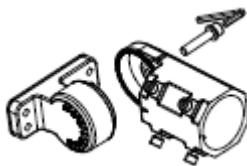

**Figure 4**



**Figure 5**

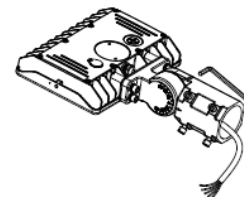

**Figure 6**

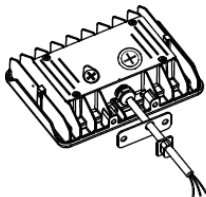

**Figure 7**

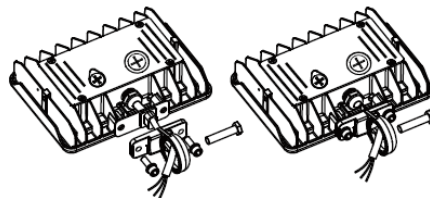

**Figure 8**

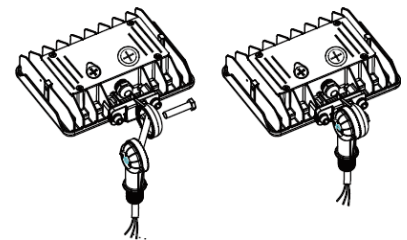

**Figure 9**

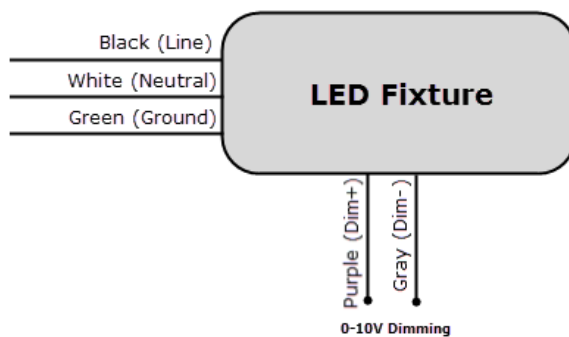

**Wiring Diagram**

**(800) 451-2606**

7905 Cochran Road, Suite 300

Glenwillow, Ohio 44139 USA

E-mail: [Venture\\_Lighting@VentureLighting.com](mailto:Venture_Lighting@VentureLighting.com)

**VentureLighting.com**

