

WattStopper®
FSIR-100

USING THE FSIR-100 CONFIGURATION TOOL

The FSIR-100 Wireless IR Configuration Tool is a handheld tool for changing defaults and testing of WattStopper devices. It provides wireless access to the devices for parameter changes and testing.

The FSIR-100 display shows menus and prompts to lead you through each process. The navigation pad provides a simple way to navigate through the customization fields.

Within a certain mounting height of the sensor, the FSIR-100 allows modification of the system without requiring ladders or tools; simply with a touch of a few buttons.

The FSIR-100 IR transceiver allows bi-directional communication between the device and the FSIR-100 configuration tool. Simple menu screens let you see the current status of the sensor and make changes. It can change device parameters such as high/low mode, sensitivity, time delay, cut off and more. With the FSIR-100 you can also establish and store device parameter profiles.

BATTERIES

The FSIR-100 operates on three standard 1.5V AAA Alkaline batteries or three rechargeable AAA NiMH batteries. The battery status displays in the upper right corner of the display. Three bars next to BAT= indicates a full battery charge. A

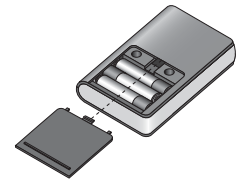

warning appears on the display when the battery level falls below a minimum acceptable level. To conserve battery power, the FSIR-100 automatically shuts off 10 minutes after the last key press.

- If communication is not successful, (if possible) move closer to the sensor.
- If still not successful, there may be too much IR interference from other sources. Programming the unit at night when there is no daylight available may be the only way to communicate with the sensor.

NAVIGATION

Navigate from one field to another using (up) or (down) arrow keys. The active field is indicated by flashing (alternates) between yellow text on black background and black text on yellow background.

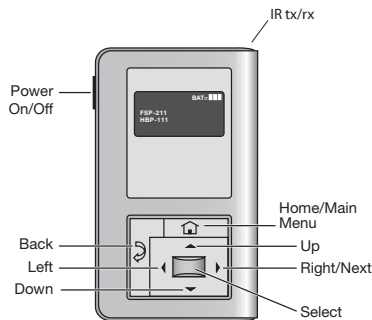

Once active, use the Select button to move to a menu or function within the active field. Value fields are used to adjust parameter settings. They are shown in “less-than/greater-than” symbols: <value>. Once active, change them using (left) and (right) arrow keys. The right key increments and the left key decrements a value. Selections wrap-around if you continue to press the key beyond maximum or minimum values. Moving away from the value field overwrites the original value. The Home button takes you to the main menu. The Back button can be thought of as an undo function. It takes you back one screen. Changes that were in process prior to pressing the key are lost.

IR COMMUNICATION

IR communication can be affected by the mounting height of the sensor and high ambient lighting such as direct daylight or electric light such as floodlights, and some halogen, fluorescent lamps, LED's.

When trying to communicate with the device, be sure to be positioned under the sensor without any obstructions. Every time the commissioning tool establishes communication with the device, the controlled load will cycle.

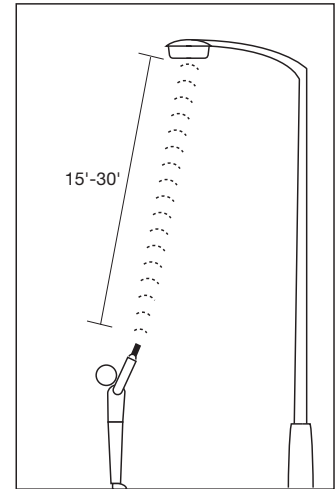

* Distance may vary depending on the lighting environment

FSP-211

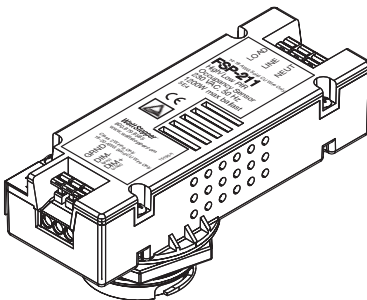

The FSP-211 is a motion sensor that dims lighting from high to low based on movement. This slim, low-profile sensor is designed for installation inside the bottom of a light fixture body. The PIR lens module connects to the FSP-211 through a 1.30" diameter hole in the bottom of the fixture.

The sensors use passive infrared (PIR) sensing technology that reacts to changes in infrared energy (moving body heat) within the coverage area. Once the sensor stops detecting movement and the time delay elapses lights will go from high to low mode and eventually to an OFF position if it is desired. Sensors must directly “see” motion of a person or moving object to detect them, so careful consideration must be given to sensor luminaire placement and lens selection. Avoid placing the sensor where obstructions may block the sensor's line of sight.

COMPONENTS

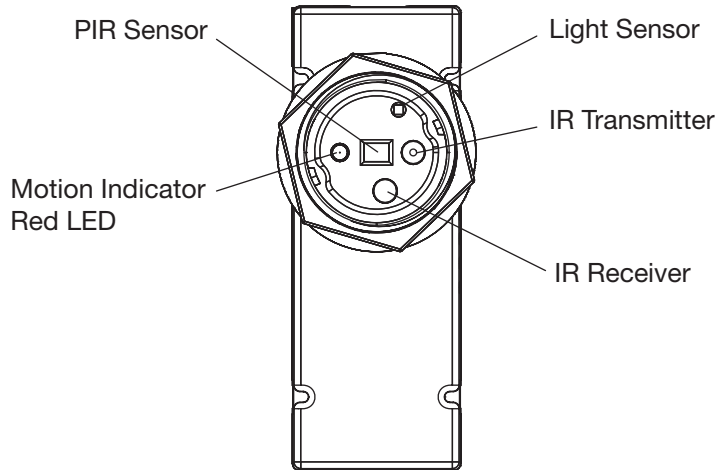

FSP-211 SCREENS

Home Menu



Choose FSP-211 Press Select

The Home (or Main) menu displays after the power-up process completes. It contains information on the battery status and sensor menu choices. Press the up or down buttons to highlight the desired sensor then press Select.

High Mode

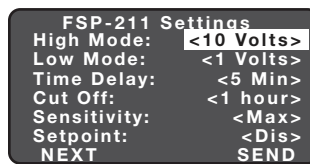

Press the Left/Right Arrow to Increase or Decrease Volts

When the sensor detects motion the dimming control output ramps up to the selected HIGH light level (default is 10V).

Range: 0 V to 10 V
Increments: 0.2 V

To program the FSP-211 with the selected parameters go to SEND and press the Select button. The controlled load should cycle once the sensor is updated.

New Settings

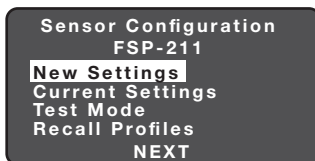

Press Select

New Settings allow you to select the different sensor parameters such as: High/Low Mode, Time Delay, Cut Off, Sensitivity, Setpoint and Ramp/Fade rates.

Low Mode

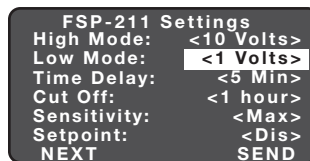

Press the Left/Right Arrow to Increase or Decrease Volts

After the sensor stops detecting motion and the time delay expires the dimming control output fades down to the selected LOW light level (default is 1V).

Range: OFF, 0 V to 9.8 V
Increments: 0.2 V

Time Delay

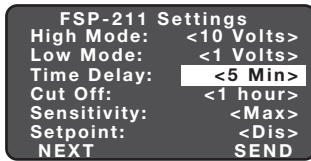

Press the Left/Right Arrow to Raise or Lower Time Delay



The time period that must elapse after the last time the sensor detects motion for the lights to fade to LOW mode (default is 5 min).

Range: 30 sec, 1 min to 30 min
 Increments: 1 min

Cut Off

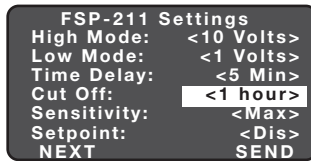

Press the Left/Right Arrow to Increase or Decrease Cut Off



The time period that must elapse after the lights fade to Low Mode and the sensor detects no motion for the lights to turn OFF (default is 1 hour).

Range: Disable (No cut off, lights will stay in low mode) 1 min to 59 min, 1 hr to 5 hr (press and hold should cause to move faster through the increments)

Increments: 1 min or 1 hr

Sensitivity

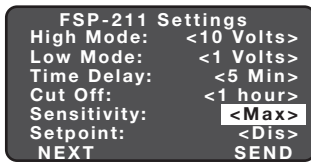

Press the Left/Right Arrow to Increase or Decrease Sensitivity



The response of the PIR detector to motion within the sensor's coverage area (default is max).

Range and Sequence: On-Fix, Off-Fix, Low, Med, Max

(On-Fix: relay closed, occupancy detection disabled; Off-Fix, relay open, occupancy detection disabled.)

Hold Off Setpoint

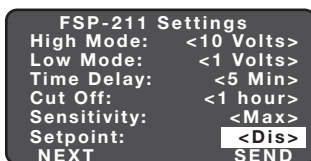

Press the Left/Right Arrow to Increase or Decrease Setpoint



The selectable ambient light level threshold that will hold the lights off or at LOW level when the sensor detects motion (default is Disable).

Range: Auto, Disable, 1 fc to 250 fc

Increments: 1 fc (press and hold should cause to move faster thru the increments)

Sequence: Disable, 1 fc to 250 fc

The Auto option invokes an automatic calibration procedure to establish an appropriate setpoint based upon the contribution of the electric light. As part of this procedure, the controlled load is turned on to warm up the lamp, and then it is switched off and on eight times, terminating in an off state. After this process, a new setpoint value is automatically calculated. During this time, communication to the FSP-211 is disabled.

Next

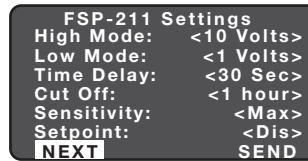

Choose NEXT to View More Settings



To view more settings go to NEXT and press the Select button

Ramp Up

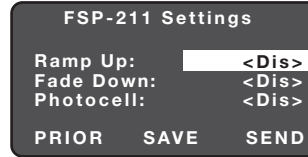

Press the Left/Right Arrow to Increase or Decrease Sec



Time period for light level to increase from LOW to HIGH (default is Disable; light/load switches instantly).

Range: Disable, 1 sec to 60 sec
 Increments: 1 sec

Fade Down



Press the Left/Right Arrow to Increase or Decrease Sec



Time period for light level to decrease from HIGH to LOW (default is Disable; light/load switches instantly).

Range: Disable, 1 sec to 60 sec
 Increments: 1 sec

Photocell On/Off

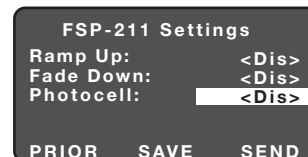

When the light level exceeds this setting, the lights will turn off even when the space is occupied. Once the light level exceeds this setting, the sensor will wait and monitor for a short period of time

in order to confirm the light level increase is not temporary before forcing the lights to go off. When light level goes below the settings, the light will turn on even without motion detection. This feature is disabled by default. If using this setting in combination with the Hold Off setpoint, there must be at least 10fc of dead band between the two settings. The Photocell setpoint is automatically set to maintain at least 10fc of dead band above the Hold Off setpoint to help avoid load cycling.

Prior



Press the Down Arrow to Choose PRIOR



To go back to previous settings go to PRIOR and press the Select button.

Send



Press the Down Arrow to Choose SEND

To program the FSP-211 with the selected parameters go to SEND and press the Select button. The controlled load should cycle once the sensor is updated.

Light Level



Displays the light level at the FSP-211. The light level reading can be used as a reference for setpoint adjustments.

Save



Press the Down Arrow to Choose SAVE

To Save these New Settings parameters as one of the profiles go to SAVE and press the Select button.

Done

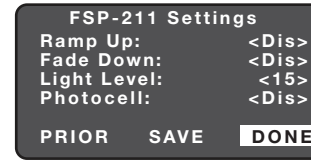

Press the Down Arrow to Choose DONE

To go to the FSP-211 Home screen go to DONE and press the Select button.

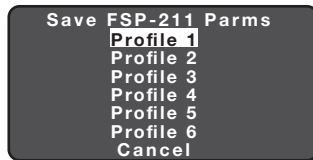

Press the Up/Down Arrow to Choose Profile

Test Mode

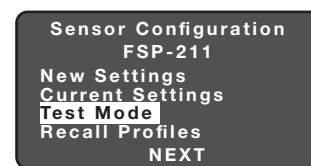

Choose Test Mode

Test Mode shortens timeouts for High/Low and Cut Off, to allow quick verification of settings. Test Mode disables automatically after 5 minutes.

Current Settings

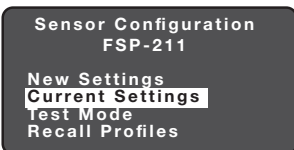

Choose Current Settings



Point and Press Select

Enable/Disable

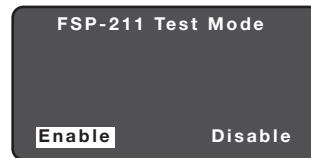

Press the Left/Right Arrow to Enable or Disable Test Mode

Test Mode has been enabled.

Current Settings allow you to recall the parameters for a specific sensor. These are read only parameters.

View Current Settings

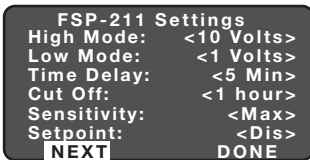

Press Select to View More Settings

Highlight and press Select to view the Current Settings.

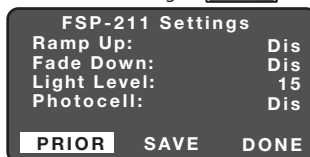

Press the Down Arrow to Choose PRIOR

To go back to previous settings go to PRIOR and press the Select button.

Recall Profiles

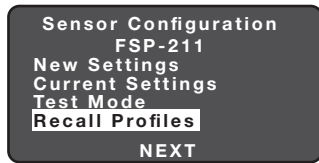

Choose Rec all Pr ofiles Press Select

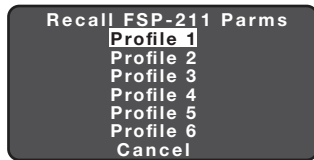

Press the Up/Down Arrow to Choose a Specific Pr ofile Press Select

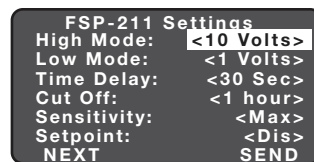

Recall Profiles allow the user to select the saved parameter profiles. This feature is used when programming multiple FSP-211's with the same parameters.

Selecting a specific profile allow the user to also change the parameters such as: High/Low Mode, Time Delay, Cut Off, Sensitivity, Setpoint and Ramp/Fade rates.

Lock Settings

IR communication locks to prevent unauthorized changes of FSP-211 parameters.

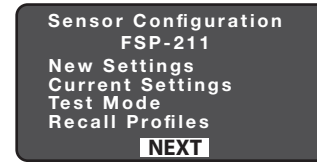

Press Select

To view more sensor configuration settings go to NEXT and press the Select button.

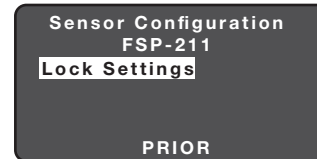

Press Select

FSP-211 default settings communicate with the FSIR-100; however, this security feature limits communication only for authorized installers who have access to main power supply to the FSP-211 sensor. Press Select to set Lock Delay or press PRIOR to go back.

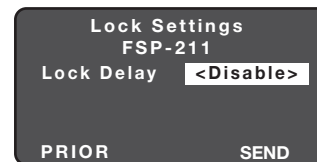

Press the Left/Right Arrow to Disable or set Lock Delay time

Factory default Lock Delay setting is disabled and FSP-211 parameter can change with any FSIR-100 at anytime. To enable Lock Delay with time, select lock delay time and press SEND to set delay time in the FSP-211. Its parameter changes with the FSIR-100 will be locked after the specified timer expires from the last message. At the end of the specified time the FSP-211 will be locked unless there is a power cycle. Any locked sensor needs power cycling to initiate any configuration through the FSIR-100. To permanently disable Lock Delay after power cycling, select Disable and press SEND.

Range: 10 min - 240 min
Increments: 1 min

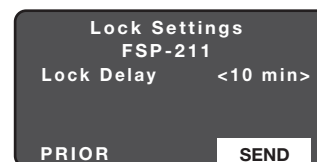

Press Select

Highlight SEND and press Select to enable lock settings.



This screen will appear if the FSP-211 is locked. If it is locked, cycle the power.