



VENTURE  
LIGHTING

# LIGHTING SOLUTIONS



*THE LIGHTING SOLUTIONS YOU NEED, WHETHER IT'S **HID** OR **LED***



# WELCOME TO VENTURE LIGHTING SOLUTIONS

## CONTENTS

Introduction .....1-2

### LED Interior Luminaires

- Highbays .....4-7
- Panels .....8
- Troffers .....9-10
- Wrap fixture .....11
- Vapor-tight .....11
- Downlights .....12

### LED Exterior Luminaires

- Wallpacks .....14-16
- Floods .....17-18
- Dust to Dawn .....19
- Area .....20-22
- Canopy .....23-24
- Gas Station Canopy .....25
- Recessed Canopy .....26
- Parking Garage .....27-28
- Wireless Controls .....29

### LED Lamps

- Retrofit Lamps .....30-31
- T8 Lamps .....32

### HID Products

- Metal Halide Lamps .....34
- Metal Halide Ballasts .....35
- SPL Long Life Lamps .....35
- Sports Lamps & Ballasts .....35
- Natural White Lamps .....36
- Natural White Ballasts .....36
- Energy Master Lamps .....36
- White-Lux HPS Retrofit .....36
- HPS Lamps .....37
- HPS Ballasts .....37
- Capacitors .....37
- Replacement Igniters .....37

Warranty Information .....38



**VENTURE**  
**LIGHTING**

**D**riven by the increasing demand for energy efficiency, Venture Lighting has always been a pioneer of light source technology, firstly transforming the HID lighting market with the introduction of the revolutionary Uni-Form® pulse start metal halide system with formed-body arc tube in lamps and more recently taking advantage of the rapid developments in solid state technology to bring you a world class range of LED lighting solutions paired with a best in class wireless control system.

Venture Lighting customers are assured the very best technology combined with the highest level of service; in short, everything expected from a global leader in the lighting industry. Venture's dedicated technical and customer service teams offer full technical support on all of our products.

We believe that the best LED and HID lighting products should be complemented by the very best service and support, that's why we strive to offer our customers, large and small, a level of service unequalled in the industry. Our customer service team supported by our experienced technical engineering department is always there to provide expert advice and to help you with all your lighting systems requirements.



*energy saving*



*longer life*



*superior performance*



*easy to install*



*5 year warranty*



*all weather*



*technical support*



# WHY CHOOSE VENTURE LIGHTING



52W LED 2x4 Panels

*THE LIGHTING SOLUTIONS YOU NEED, WHETHER IT'S **HID** OR **LED***

# INDOOR LIGHTING SOLUTIONS



200W Modern Highbay

# LED HIGHBAY LIGHTING



## 120-277V

## Modern

Wattage	Order Code	Lumen Output	Color Temp.	CRI	Beam Angle	Lumen Maint. @50,000 hours <sup>†</sup>	Calc. L70@25°C Amb.(hrs) <sup>†</sup>	Fig.	Fixt. Color	Amp. 120V	Draw (A) 277V	Replaces Existing HID Wattages	DLC Model Number
90W	HB38477*	9500	4000K	80	120°	92%	240,000	A	White	0.76	0.34	250W	HW-090N8-AA
90W	HB64698	11400	5000K	70+	120°	92%	240,000	A	White	0.76	0.34	250W	HW-090C-AA
150W	HB71452*	15750	4000K	80	90°	92%	230,000	B	White	1.25	0.56	400W	HW-150N8-AB
150W	HB95488	18900	5000K	80	90°	92%	230,000	B	White	1.25	0.56	400W	HW-150C8-AB
200W	HB20943*	21000	4000K	80	90°	92%	223,000	C	White	1.69	0.73	750W	HW-200N8-AB
200W	HB22920	25000	5000K	80	90°	92%	223,000	C	White	1.69	0.73	750W	HW-200C8-AB
300W	HB31479*	39395	4000K	70	90°	77%	68,000	D	White	2.60	1.21	up to 1000W	HW-300N-AB
300W	HB41782*	40108	5000K	70+	90°	77%	68,000	D	White	2.60	1.21	up to 1000W	HW-300C-AB

## 347-480V

## Modern

Wattage	Order Code	Lumen Output	Color Temp.	CRI	Beam Angle	Lumen Maint. @50,000 hours <sup>†</sup>	Calc. L70@25°C Amb.(hrs) <sup>†</sup>	Fig.	Fixt. Color	Amp. 120V	Draw (A) 277V	Replaces Existing HID Wattages	DLC Model Number
100W	HB54216*	12120	4000K	70	120°	92%	240,000	D	White	0.30	0.22	250W	HW-100N-BA
100W	HB19238*	12165	5000K	70+	120°	92%	240,000	D	White	0.30	0.22	250W	HW-100C-BA
150W	HB27813*	18560	4000K	70	90°	92%	230,000	D	White	0.45	0.33	400W	HW-150N-BB
150W	HB27146*	18970	5000K	70+	90°	92%	230,000	D	White	0.45	0.33	400W	HW-150C-BB
200W	HB41682*	24040	4000K	70	90°	92%	223,000	D	White	0.58	0.43	750W	HW-200N-BB
200W	HB28334*	24670	5000K	70+	90°	92%	223,000	D	White	0.58	0.43	750W	HW-200C-BB

## High Ambient Temperature

## Modern

Wattage	Order Code	Lumen Output	Color Temp.	CRI	Beam Angle	Lumen Maint. @50,000 hours <sup>†</sup>	Calc. L70@25°C Amb.(hrs) <sup>†</sup>	Fig.	Fixt. Color	Amp. 120V	Draw (A) 277V	Replaces Existing HID Wattages	Model Number
200W	HB19216*	24500	4000K	70	90°	92%	223,000	D	White	1.69	0.73	750W	HW-300N-AB-HT
200W	HB19737*	24670	5000K	70+	90°	92%	223,000	D	White	1.69	0.73	750W	HW-300C-AB-HT

Note: Operating temperature for HB19737 is -30°C to 60°C

\* Contact for lead time

† Lumen maintenance data is based on LED testing per IESNA LM-80-08 and projected per IESNA TM-21-11

## Dimensions

Figure A

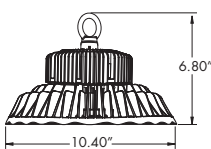

Figure B

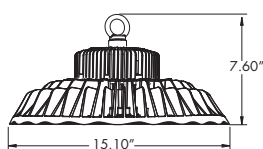

Figure C

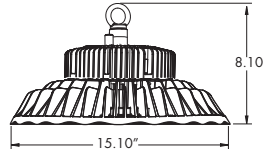
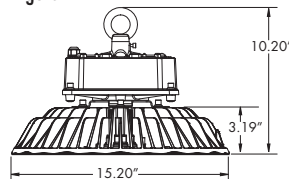
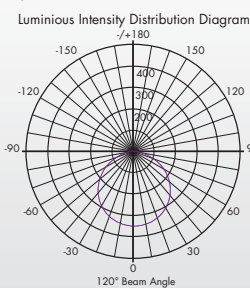

Figure D



## Photometrics

### 90W



### 150W, 200W

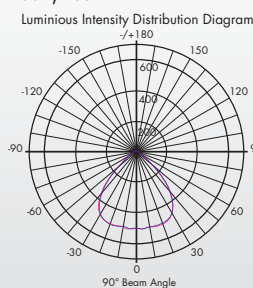

## Accessories (Order as separate line items)

- LN13528 - 90° plastic lens for 90W highbay
- LN13597 - Clear plastic lens for 90W highbay
- LN13416 - 120° plastic lens for 100W-200W highbay
- LN13421 - 120° glass lens for 100W-300W highbay
- LN13632 - Clear plastic flat lens for 100W-300W highbay
- LN28431 - 50° plastic lens for 100W-200W highbay
- RF13376 - Aluminum shield for 90W highbay, silver
- RF13388 - Aluminum shield for 100W-300W highbay
- RF13912 - Acrylic reflector for 100W-300W highbay
- AC78196 - Pendant mount kit for 150W-200W, white
- AC78182 - Pendant mount kit for 90W, white
- AC53904 - Pendant mount kit for select Modern fixtures
- KT14231 - 90W sensor mount kit
- KT14791 - 100-300W sensor mount kit
- 6500-026 - 10' safety cable
- PH41623 - Motion sensor only (S1)
- PH77409 - Motion/photocell/dimming sensor (S2)

Note: S1 and S2 are factory installed sensors.

Factory installed plug options are available, see spec sheets for details



IP65



# LED HIGHBAY LIGHTING

## Commerce

Wattage	Order Code	Lumen Output	Color Temp.	CRI	Lumen Maint. @50,000 hours†	Calc. L70@25°C Amb.(hrs)‡	Fixture Color	Amp. Draw (A) 120V	Amp. Draw (A) 277V	Replaces Existing HID Wattages	DLC Model Number
120W	HB73260	14200	4000K	84	87%	133,000	White	1.00	0.44	250W	HBX-120NA
160W	HB84680	18700	4000K	84	87%	133,000	White	1.35	0.61	400W	HBX-165NA
200W	HB17846*	23300	4000K	84	87%	133,000	White	1.72	0.76	400W+	HBX-200NA

\* Contact for lead time

† Lumen maintenance data is based on LED testing per IESNA LM-80-08 and projected per IESNA TM-21-11

## Benefits and Features

- Rugged housing with a durable powder coat finish
- Locking hook and pendant mount accessory included
- Available 16" diameter clear acrylic optic accessory ordered separately
- Rated for damp and dry locations
- Cooler running LED chip which leads to longer life, better efficacy, and color consistency.
- Easy upgrade for HID and fluorescent fixtures
- 133,000 hour life
- 5 year warranty
- 80% Energy Savings
- Ambient operating temperature range -30°C to 45°C
- 0-10V DC dimming capability
- DesignLights Consortium® (DLC) qualified
- 4kV surge protection

NOTE: shown with RF53116, 16" clear acrylic optic ordered separately



NOTE: shown with KT21589 and PH41623 motion sensor ordered separately



## Photometrics

Luminous Intensity Distribution Diagram

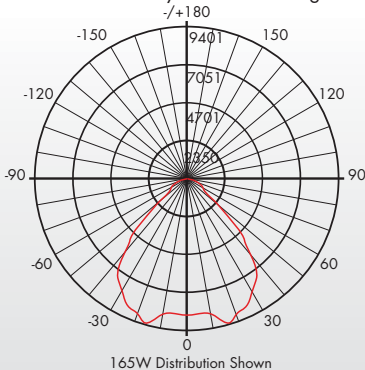

## Dimensions

Weight: 15.0 lbs (6.80 kg)

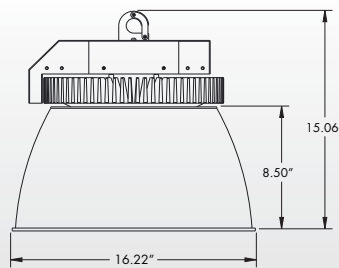

## Accessories (Order as separate line items)

- RF53116 16" diameter clear acrylic optic
- KT21589 Sensor Mounting Arm - Commerce Highbay
- PH41623 Motion Only Control Sensor
- PH77409 Motion/Photocell/Dimming Control Sensor
- 6500-026 - 10' safety cable

Factory installed plug options are available, see spec sheets for details



# LED HIGHBAY LIGHTING

## Wave Aisle Lighter

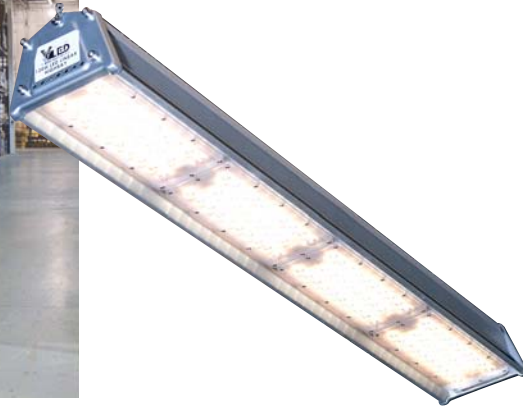

Wattage	Order Code	Lumen Output	Color Temp.	CRI	Lumen Maint. @50,000 hours†	Calc. L70@25°C Amb.(hrs)†	Fixture Color	Amp. Draw (A) 120V	Amp. Draw (A) 277V	Replaces Existing HID Wattages	DLC Model Number
90W	HB42342	10100	5000K	70	90%	159,000	Matte Silver	0.76	0.33	250W	HWL-090C-AD
120W	HB26502	12900	5000K	70	90%	157,000	Matte Silver	1.00	0.44	400W	HWL-120C-AD
150W	HB61298	16500	5000K	70	90%	154,000	Matte Silver	1.26	0.55	400W	HWL-150C-AD

† Lumen maintenance data is based on LED testing per IESNA LM-80-08 and projected per IESNA TM-21-11

### Benefits and Features

- Extruded aluminum heat sink housing with powder coated aluminum end caps and stainless steel hardware
- Precision optic, polycarbonate lens achieves 60 x 90 distribution
- Optical chamber is sealed and gasketed
- Operating temperature range of -30° C to 50° C
- DesignLights Consortium® (DLC) qualified
- 3X longer life than traditional technology, reducing maintenance costs
- 5 year warranty
- 80% Energy Savings
- Universal 120-277V 50/60 Hz input
- 0-10V DC dimming standard to maximize energy savings
- DLC certified and cULus rated for damp and dry locations and IP65 rated
- (2) aircraft cables included with fixture for mounting

### Photometrics

Luminous Intensity Distribution Diagram

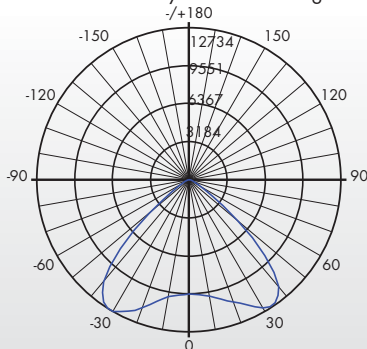

### Dimensions

90W: Weight: 10.4 lbs (4.71 kg)

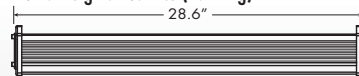

120W: Weight: 12.6 lbs (5.72 kg)

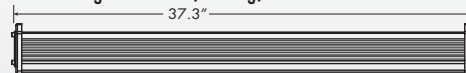

150W: Weight: 15.2 lbs (6.89 kg)

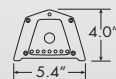

### Accessories (Order as separate line items)

- KT14682** Sensor mounting kit for Wave linear highbay
- PH41623** - Motion sensor only (S1)
- PH77409** - Motion/photocell/dimming sensor (S2)

Note: S1 and S2 are factory installed sensors.

Factory installed plug options are available, see spec sheets for details



# LED HIGHBAY LIGHTING

## Clear Lens

Wattage	Order Code	Lumen Output	Color Temp.	CRI	Life Hours	Fixture Color	Amp. Draw (A)		DLC Model Number
							120V	277V	
110W	HB17813*	14740	4000K	80	50,000	White	0.93	0.45	HBL2-110WNAC-BF2
110W	HB42342	14400	5000K	80	50,000	White	0.93	0.45	HBL2-110WCAC-BF2
160W	HB27818*	21700	4000K	80	50,000	White	1.35	0.61	HBL2-160WNAC-BF2
160W	HB41918	21870	5000K	80	50,000	White	1.35	0.61	HBL2-160WCAC-BF2

## Frosted Lens

Wattage	Order Code	Lumen Output	Color Temp.	CRI	Life Hours	Fixture Color	Amp. Draw (A)		DLC Model Number
							120V	277V	
110W	HB23814*	14300	4000K	80	50,000	White	0.93	0.45	HBL2-110WNAF-BF2
110W	HB51843	14400	5000K	80	50,000	White	0.93	0.45	HBL2-110WCAF-BF2
160W	HB31452*	21060	4000K	80	50,000	White	1.35	0.61	HBL2-160WNAF-BF2
160W	HB52728	21870	5000K	80	50,000	White	1.35	0.61	HBL2-160WCAF-BF2

\* Contact for lead time

## Benefits and Features

- V-hook (2pcs) and 42" chain accessories supplied with each fixture for suspended mount
- Versatile and easy to install - pendant or surface mount accessories sold separately
- Operating temperature range of -30° C to 45° C
- Universal 120-277V 50/60 Hz input
- Clear or frosted lens versions available
- 0-10V Dimming standard
- Rated for damp and dry locations
- Optional wire guard available

## Photometrics

### 110W LED Linear Highbay

Luminous Intensity Distribution Diagram

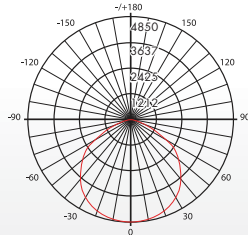

### 160W LED Linear Highbay

Luminous Intensity Distribution Diagram

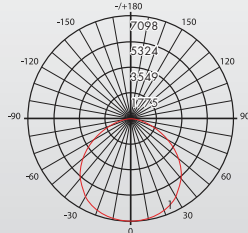

## Dimensions

110W: Weight: 10.2 lbs (4.63 kg)

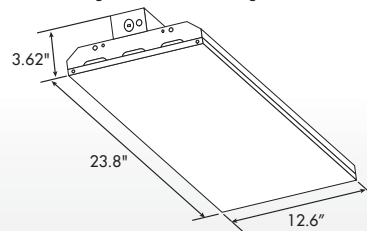

160W: Weight: 14.0 lbs (6.35 kg)

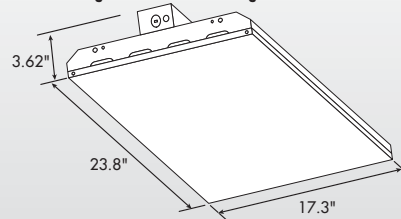

## Accessories (Order as separate line items)

- KT21343** - Wire guard kit with hardware for 110W
- KT18519** - Wire guard kit with hardware for 160W
- KT16782** - Pendant mount kit with hardware (white)
- KT27604** - Surface mount kit with hardware (white)
- KT37197** - Sensor mount kit with hardware (white)
- AC24512** - 1 meter chain with S-hooks (2pcs) (replacement)
- AC28841** - V-Hook (2 pcs set) for 110W Linear HB (replacement)
- AC19722** - V-Hook (2 pcs set) for 160W Linear HB (replacement)
- LN18714** - Clear Lens for 110W for field installation
- LN18725** - Clear Lens for 160W for field installation
- LN18614** - Frosted Lens for 110W for field installation
- LN18625** - Frosted Lens for 160W for field installation



## LED Panels



Easy to install, simply remove old fluorescent troffer fixture, and use the existing T-bar application to secure LED panel. Direct wire and start saving.



Panel Size	Wattage	Order Code	Lumen Output	Color Temperature	CRI	Life Hours	Fixture Color	Amp. Draw (A) 120V	Amp. Draw (A) 277V	Replaces Existing Wattages	DLC Model Number
1x4	36W	PN121852	3350	3500K	80	50,000	White	0.32	0.14	64W	VL1-PA14-036B-A-AG00
1x4	36W	PN14614	3950	4000K	80	50,000	White	0.32	0.14	64W	PD14-036N-ANR-W00
1x4	36W	PN18514	3600	5000K	80	50,000	White	0.32	0.14	64W	VL1-PA14-036C-A-AG00
2x2	40W	PN12832	4600	3500K	80	50,000	White	0.34	0.15	64W	PD22-40B-ANR-W00
2x2	40W	PN26744	4600	4000K	80	50,000	White	0.34	0.15	64W	PD22-40N-ANR-W00
2x2	40W	PN41258	4735	5000K	80	50,000	White	0.34	0.15	64W	PD22-40C-ANR-W00
2x4	48W	PN62316	5445	4000K	80	50,000	White	0.45	0.20	96W - 128W	PD24-48N-ANR-W00
2x4	48W	PN45124	5520	5000K	80	50,000	White	0.45	0.20	96W - 128W	PD24-48C-ANR-W00
2x4	52W	PN32817	5800	3500K	80	50,000	White	0.45	0.20	96W - 128W	VL1-PA24-052B-A-AG00

### Photometrics

#### 52W 2x4 LED Panel

Luminous Intensity Distribution Diagram

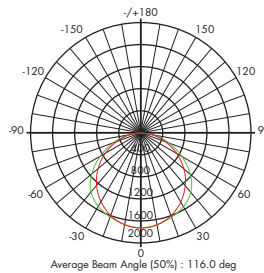

#### 40W 2x2 LED Panel

Luminous Intensity Distribution Diagram

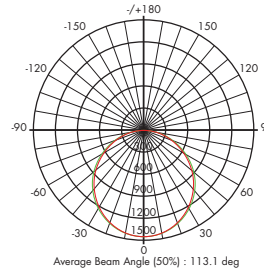

### Benefits and Features

- Glass-free construction with internal driver
- Edge-lit optics, low glare and easy on the eyes
- Thin profile and easy to handle
- For retrofit or new construction with T-Bar applications
- DesignLights Consortium® (DLC) qualified
- 50,000 hour life; 65% Longer Life
- 5 year warranty
- 50% Energy Savings
- Rated for dry locations
- IC rated for direct contact with insulation
- Universal 120-277V 50/60 Hz input
- 0-10V DC dimming standard to maximize energy savings
- Superior color consistency within a 4-step MacAdam ellipse and greater than 80 CRI

### Dimensions

48W/52W 2x4 LED Panel  
Weight: 20.2 lbs (9.16 kg)

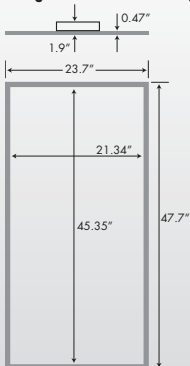

40W 2x2 LED Panel  
Weight: 10.6 lbs (4.80 kg)

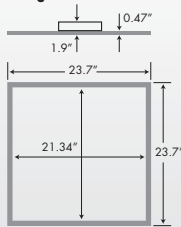

36W 1x4 LED Panel  
Weight: 10.6 lbs (4.80 kg)



### Accessories (Order as separate line items)

- BB23468** - Battery back-up
- KT14136** - 1x4 Drywall Mount Kit, White
- KT20945** - 1x4 Surface Mount Kit, White
- KT18101** - 2x2 Drywall Mount Kit, White
- KT14156** - 2x2 Surface Mount Kit, White
- KT18916** - 2x4 Drywall Mount Kit, White
- KT18522** - 2x4 Surface Mount Kit, White

Dry wall mounting kits

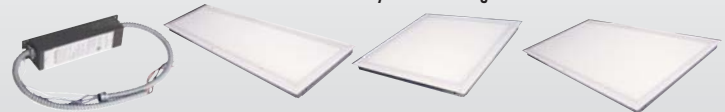

Surface mounting kits



# LED TROFFERS

## Troffers

Wattage	Order Code	Lumen Output	Color Temp.	CRI	Fixture Size	Life Hours	Fixture Color	Amp. Draw (A)	120V	277V	Replaces Existing Fluorescent	DLC Model Number
32W	TR16834	3720	4000K	80	2x2	50,000	White	0.29	0.13		2x2	TR22-32NA-00
42W	TR21705	5120	4000K	80	2x4	50,000	White	0.37	0.17		2x4	TR24-42NA-00

## Benefits and Features

- High quality, economical alternative to fluorescent
- Powered by LED lighting technology
- Highest return on initial investment over the life time of the fixture
- Ideal for office spaces, schools, hospitals, and many other indoor locations
- Design Lights Consortium (DLC) Premium Qualified
- New construction or replacement of existing fluorescent fixtures
- 0-10V Dimming standard
- Rated for damp and dry locations
- IC Rated



## Photometrics

### 32W 2x2 LED Troffer

Luminous Intensity Distribution Diagram

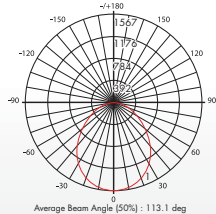

### 42W 2x4 LED Troffer

Luminous Intensity Distribution Diagram

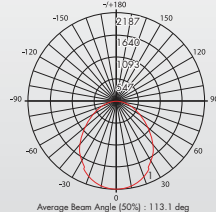

## Dimensions

### 32W 2x2 LED Troffer

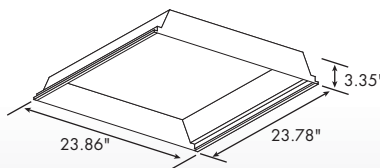

### 42W 2x4 LED Troffer

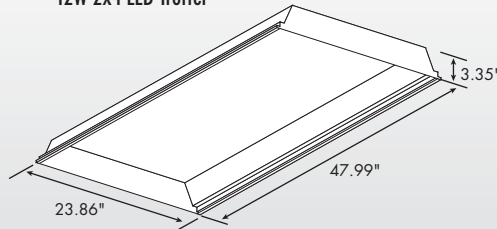

## Accessories (Order as separate line items)

- KT18101** - 2x2 Drywall Mount Kit, White
- KT18916** - 2x4 Drywall Mount Kit, White

Dry wall mounting kits

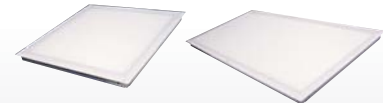

# LED VOLUMETRIC TROFFERS

## Volumetric Troffers

Wattage	Order Code	Lumen Output	Color Temp.	CRI	Fixture Size	Life Hours	Fixture Color	Amp. Draw (A)	120V	277V	Replaces Existing Fluorescent	DLC Model Number
26W	TR39826	3275	4000K	80	2x2	50,000	White	0.23	0.10		2x2	TB22-26NA-01
48W	TR51438	5970	4000K	80	2x4	50,000	White	0.41	0.20		2x4	TB24-50NA-01



### Benefits and Features

- High quality
- Economical
- Powered by LED lighting technology
- Highest return on initial investment over the life time of the fixture
- Ideal for office spaces, schools, hospitals, and many other indoor locations
- Single diffused lens
- Smooth, low glare illuminance
- Design Lights Consortium (DLC) Premium Qualified
- New construction or replacement of existing fluorescent fixtures
- 0-10V Dimming standard
- Rated for damp and dry locations
- IC Rated

### Photometrics

#### 26W 2x2 LED Volumetric Troffer

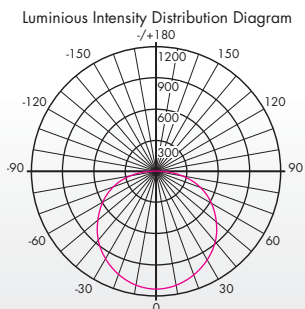

#### 48W 2x4 LED Volumetric Troffer

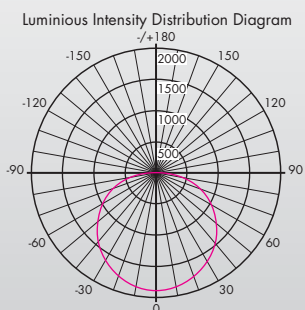

### Dimensions

#### 26W 2x2 LED Volumetric Troffer

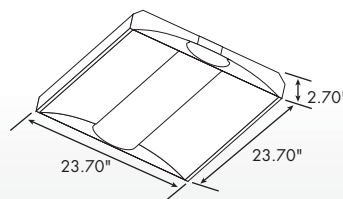

#### 48W 2x4 LED Volumetric Troffer

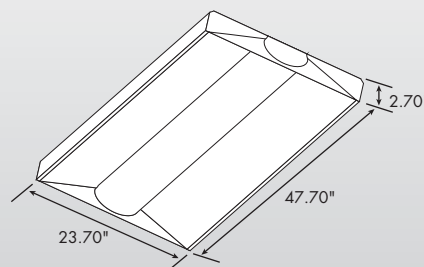

### Accessories (Order as separate line items)

- KT18101** - 2x2 Drywall Mount Kit, White
- KT18916** - 2x4 Drywall Mount Kit, White

Dry wall mounting kits

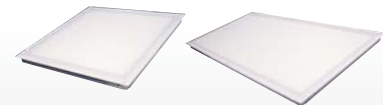

# LED LINEAR LIGHTING

## Wrap

Wattage	Order Code	Lumen Output	Color Temp.	CRI	Fixture Length	Lumen Maint. @50,000 hours <sup>†</sup>	Calc. L70@25°C Amb.(hrs) <sup>†</sup>	Fixture Color	Amp. Draw (A) 120V 277V	Replaces Existing Wattages	DLC Model Number
42W	SM16325	4550	4000K	80	4'	89%	143,000	White	0.76 0.34	(2) 32W	SM1-40NFA-00



## Photometrics

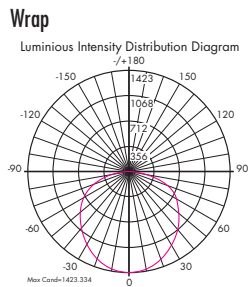

## Dimensions

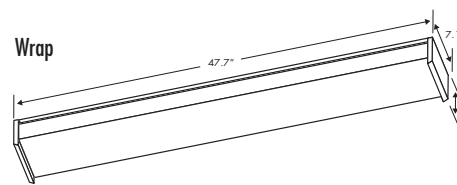

## Benefits and Features

- Universal 120-277V 50/60 Hz input
- 0-10V Dimming standard
- cULus rated
- Energy saving of up to 75%, compared to fluorescent

## Vapor-tight

Wattage	Order Code	Lumen Output	Color Temp.	CRI	Fixture Length	Lumen Maint. @50,000 hours <sup>†</sup>	Calc. L70@25°C Amb.(hrs) <sup>†</sup>	Fixture Color	Amp. Draw (A) 120V 277V	Replaces Existing Wattages	DLC Model Number
55W	VP61784	7200	4000K	80+	4'	86%	108,000	Gray	0.76 0.34	(2) 32W	VP2-56NA-BF1



## Photometrics

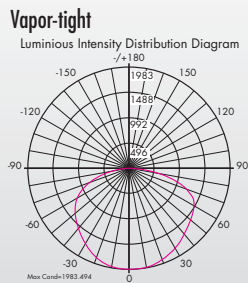

## Dimensions

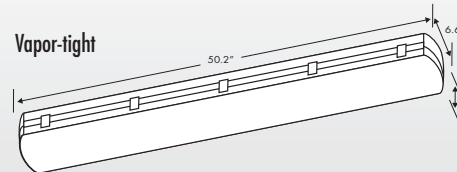

## Benefits and Features

- 3X longer life than traditional technology, reducing maintenance costs
- cULus rated for wet locations
- Light weight design allows for easy installation
- Universal 120-277V 50/60 Hz input
- 0-10V Dimming standard
- Surface mount kit and V-Hooks for dual point chain suspension included



# LED RECESSED DOWNLIGHTS

## Downlight Retrofit Kits

Wattage	Diameter	Order Code	Lumen Output	Color Temperature	CRI	Rated Life (hrs)	Beam Angle	Amp. Draw (A)		Replaces Existing		Energy Star Model Number
								120V	277V	CFL	MH	
18W	6"	DL61337	1440	4000K	80+	35,000	Med. 40°	0.15	0.07	32W	70W**	VL1-DLB018N-MDA-WHAD00
40W	8"	DL29815	2870	4000K	80+	35,000	Med. 40°	0.35	0.16	2x32W	70W	VL1-DLC040N-MDA-WHAD00
54W	8"	DL20658	4100	4000K	80+	35,000	Med. 40°	0.48	0.22	2x42W	175W	VL1-DLC054N-MDA-WHAD00
54W	10"	DL31852	3790	4000K	80+	35,000	Med. 40°	0.48	0.22	2x42W	175W	VL1-DLD054N-MDA-WHAD00

\*\* 6", Order Code DL61337 replaces 100W PAR38 Halogen lamp



### Benefits and Features

- Energy saving of up to 75%, compared to Compact Fluorescent and Metal Halide
- Upgrade standard CFL and HID 6", 8" or 10" diameter recessed luminaires to high output LED (with 80+ CRI)
- 3X longer life than traditional technology, reducing maintenance costs
- Energy Star Certified
- cULus rated for dry and damp locations
- Light weight design allows for easy installation
- Universal 120-277V 50/60 Hz input
- 0-10V DC dimming standard to maximize energy savings



### Photometrics

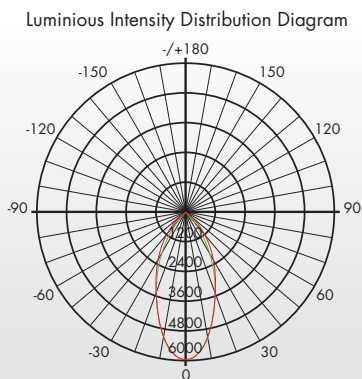

### Dimensions

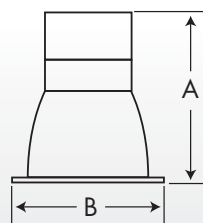

Diam.	A (in)	B (in)	Weight
6"	7.68	7.48	8.0 lbs (3.63 kg)
8"	8.98	9.29	9.0 lbs (4.08 kg)
10"	10.00	10.98	10.3 lbs (4.67 kg)

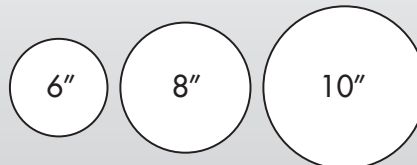

### Accessories (Order as separate line items)

- KT86415** New construction kits for 6" downlight
- KT65235** New construction kits for 8" downlight



# OUTDOOR LIGHTING SOLUTIONS



200W Environ



## Defender



Wattage	Order Code	Lumen Output	Color Temp.	CRI	Lumen Maint. @50,000 hours <sup>†</sup>	Calc. L70@25°C Amb.(hrs) <sup>†</sup>	Fixture Color	Amp. 120V	Draw (A) 277V	Replaces Existing HID Wattages	DLC Model Number
44W	WP62254*	4710	4000K	80+	93%	263,000	Bronze	0.38	0.17	250W	WPA-44NEA
44W	WP76654	5010	5000K	80+	93%	263,000	Bronze	0.38	0.17	250W	WPA-44CEA
81W	WP71923*	8770	4000K	80+	93%	250,000	Bronze	0.69	0.31	400W	WPA-81NEA
81W	WP92265	9525	5000K	80+	93%	250,000	Bronze	0.69	0.31	400W	WPA-81CEA

\* Contact for lead time

† Lumen maintenance data is based on LED testing per IESNA LM-80-08 and projected per IESNA TM-21-11



### Benefits and Features

- Rugged die cast housing with a durable powder coat finish
- Vandal resistant polycarbonate lens
- Button photocell ready - in three different locations
- Optical chamber is sealed and gasketed
- Operating temperature range of -40° C to 40° C
- 10KA surge protection
- DesignLights Consortium® (DLC) qualified
- 5 year warranty
- 80% Energy Savings
- UL Rated for wet locations
- Universal 120-277V 50/60 Hz input
- 0-10V DC dimming standard to maximize energy savings

### Photometrics

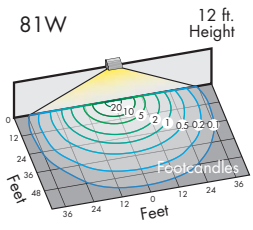
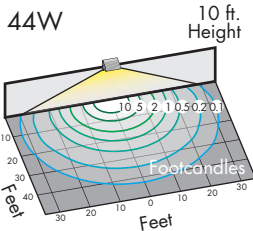

### Dimensions

44W  
Weight: 5.8 lbs (2.63 kg)

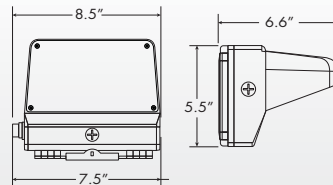

81W  
Weight: 9.6 lbs (4.35 kg)

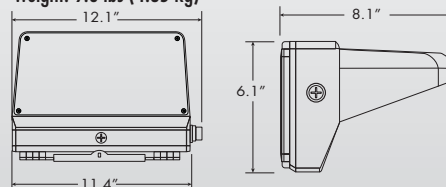

### Accessories (Order as separate line items)

- PH56903 - Button Photocell (120-277V)
- AC16546 - Escutcheon Plates for 44W
- AC16712 - Escutcheon Plates for 81W

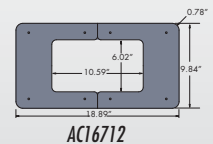
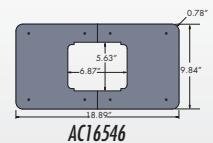

# LED WALLPACKS

## Wallpacks

Wattage	Order Code	Lumen Output	Color Temp.	CRI	Lumen Maint. @50,000 hours <sup>†</sup>	Calc. L70@25°C Amb.(hrs) <sup>†</sup>	Fixture Color	Amp. 120V	Draw (A) 277V	Replaces Existing HID Wattages	Model Number
80W	WP42135	9880	4000K	80	81%	89,000	Bronze	0.69	0.30	250W	WH2-080C-ABZ
80W	WP39412*	9900	5000K	80	81%	89,000	Bronze	0.69	0.30	250W	WH2-080N-ABZ
120W	WP69128	14770	4000K	80	81%	88,000	Bronze	1.10	0.44	400W	WH2-120C-ABZ
120W	WP56933*	14770	5000K	80	81%	88,000	Bronze	1.10	0.44	400W	WH2-120N-ABZ

\* Contact for lead time

† Lumen maintenance data is based on LED testing per IESNA LM-80-08 and projected per IESNA TM-21-11

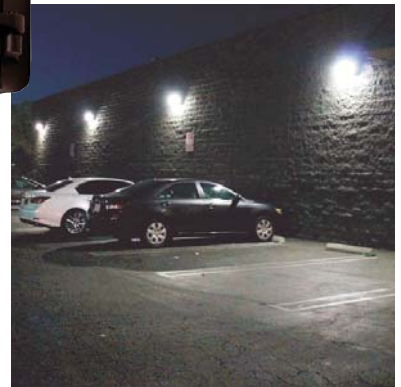

## Photometrics

80W

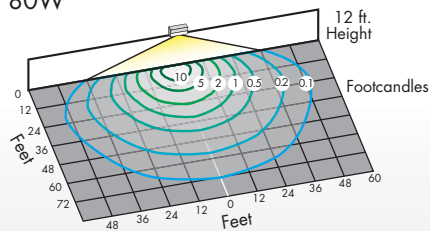

120W

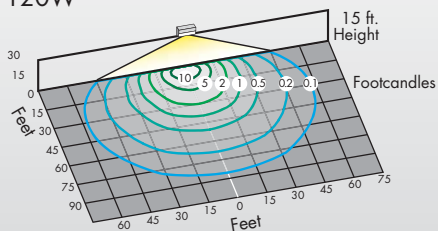

## Dimensions

80W

Weight: 15 lbs (6.8 kg)

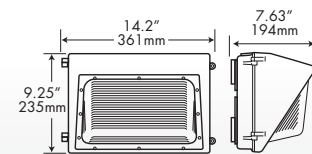

120W

Weight: 22 lbs (9.98 kg)

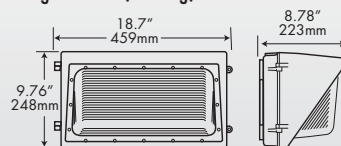

## Accessories (Order as separate line items)

- BSP3-277-LC 10KA surge protector
- PH56903 - Button Photocell (120-277V)





# LED WALLPACKS

## VWallpax

Wattage	Order Code	Lumen Output	Color Temp.	CRI	Lumen Maint. @50,000 hours <sup>†</sup>	Calc. L70@25°C Amb.(hrs) <sup>†</sup>	Fixture Color	Amp. Draw (A) 120V	Amp. Draw (A) 277V	Replaces Existing HID Wattages	DLC Model Number
20W	WP48361	1780	4000K	80	83%	101,000	Bronze	0.17	0.09	70W	WPD-20NA
20W	WP14577*	1820	5000K	80	83%	101,000	Bronze	0.17	0.09	70W	WPD-20CA
30W	WP36328	2650	4000K	80	88%	145,000	Bronze	0.25	0.12	100W	WPD-30NA
30W	WP28134*	3150	5000K	80	88%	145,000	Bronze	0.25	0.12	100W	WPD-30CA
50W	WP44708	5420	4000K	75	99%	>500,000	Bronze	0.42	0.21	175W	WPD-50NA
50W	WP76498*	5200	5000K	75	99%	>500,000	Bronze	0.42	0.21	175W	WPD-50CA
80W	WP59416	8710	4000K	75	99%	>500,000	Bronze	0.68	0.30	250W	WPD-80NA
80W	WP35127*	8000	5000K	75	99%	>500,000	Bronze	0.68	0.30	250W	WPD-80CA

\* Contact for lead time

† Lumen maintenance data is based on LED testing per IESNA LM-80-08 and projected per IESNA TM-21-11



### Benefits and Features

- Optical chamber is sealed and gasketed
- Operating temperature range of -40° C to 40° C
- DesignLights Consortium® (DLC) qualified
- 3X longer life than traditional technology, reducing maintenance costs
- 5 year warranty
- 80% Energy Savings
- Universal 120-277V 50/60 Hz input
- DLC certified and rated for wet locations

### Photometrics

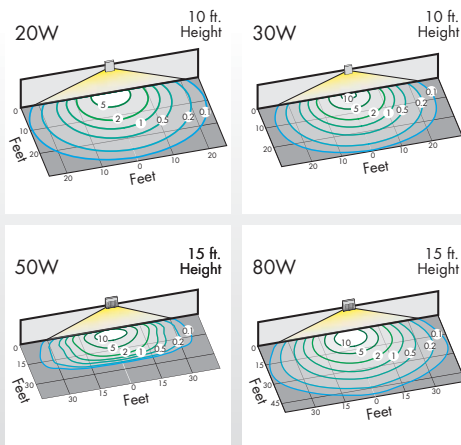

### Dimensions

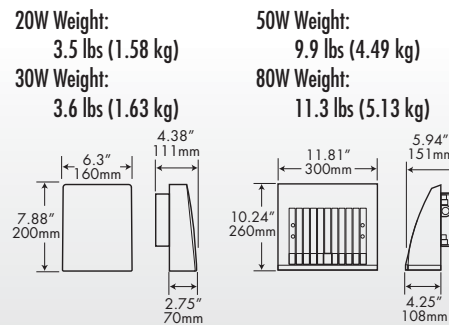

20W Weight:  
3.5 lbs (1.58 kg)

30W Weight:  
3.6 lbs (1.63 kg)

50W Weight:  
9.9 lbs (4.49 kg)

80W Weight:  
11.3 lbs (5.13 kg)

### Accessories (Order as separate line items)

- PH56903 Button Photocell (120-277V)
- KT17837 Knuckle mount conversion kit for 20W-30W fixtures only - bronze color
- KT24989 Slipfitter mount conversion kit for 50W-80W fixtures only - bronze color



PH56903



KT17837



KT24989



# LED Floods

## Round Back VFloods

Wattage	Order Code	Lumen Output	Color Temp.	CRI	Lumen Maint. @50,000 hours <sup>†</sup>	Calc. L70@25°C Amb.(hrs) <sup>†</sup>	Fixture Color	Amp. Draw (A) 120V	Amp. Draw (A) 277V	Replaces Existing HID Wattages	DLC Model Number
20W	FL59317	2250	4000K	75+	90%	163,000	Bronze	0.20	0.09	70-100W	FC4-20NA
20W	FL71458*	2280	5000K	70	90%	163,000	Bronze	0.20	0.09	70-100W	FC4-20CA
80W	FL68933	9300	4000K	75+	99%	>500,000	Bronze	0.70	0.31	70-100W	FC4-80NA
80W	FL56123*	9600	5000K	70	99%	>500,000	Bronze	0.70	0.31	70-100W	FC3-80CA

\* Contact for lead time

† Lumen maintenance data is based on LED testing per IESNA LM-80-08 and projected per IESNA TM-21-11

## Benefits and Features

- Rugged die cast housing with a durable powder coat finish
- Twist lock photocell receptacle and shorting cap included with the fixture (80W fixture only)
- Optical chamber is sealed and gasketed
- Operating temperature range of -40° C to 40° C
- 10KA surge protection
- DesignLights Consortium® (DLC) qualified
- 5 year warranty
- 80% Energy Savings
- Rated for wet locations

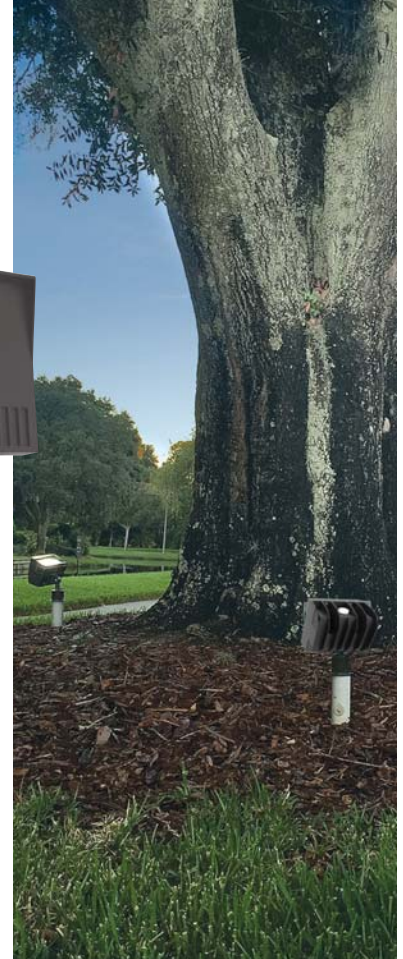

## Photometrics

20W

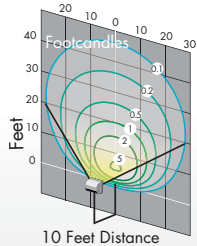

80W

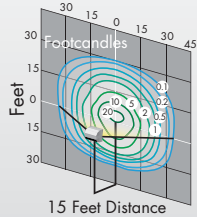

## Dimensions

20W

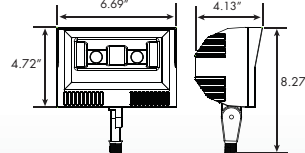

80W

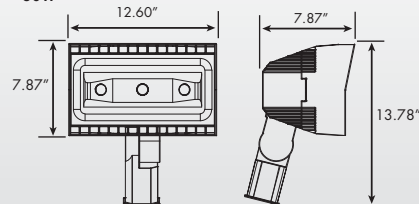

## Accessories (Order as separate line items)

- KT56256** U-bracket accessories kit for 20W roundback flood, bronze
- KT56338** U-bracket accessories kit for 80W roundback flood bronze
- PH12415** Twist lock photocell (120-277V)



# LED FLOODS AND AREA LIGHTING



## 120-277V

Wattage	Order Code	Lumen Output	Color Temp.	CRI	Lumen Maint. @50,000 hours <sup>†</sup>	Calc. L70@25°C Amb.(hrs) <sup>†</sup>	Fixture Color	Amp. Draw (A) 120V	Amp. Draw (A) 277V	Replaces Existing HID Wattages	DLC Model Number
121W	FL14587*	13950	4000K	80+	93%	268,000	Bronze	1.10	0.45	400W	FA-121N5A
121W	FL41605	14453	5000K	80+	93%	268,000	Bronze	1.10	0.45	400W	FA-121C5A
212W	FL21258*	23640	4000K	80+	93%	258,000	Bronze	1.78	0.78	1000W	FA-212N5A
212W	FL00502	25343	5000K	80+	93%	258,000	Bronze	1.78	0.78	1000W	FA-212C5A

## V-Flood

## 347-480V

Wattage	Order Code	Lumen Output	Color Temp.	CRI	Lumen Maint. @50,000 hours <sup>†</sup>	Calc. L70@25°C Amb.(hrs) <sup>†</sup>	Fixture Color	Amp. Draw (A) 347V	Amp. Draw (A) 480V	Replaces Existing HID Wattages	DLC Model Number
121W	FL15312*	13700	4000K	80+	93%	268,000	Bronze	0.36	0.27	400W	FA-120N5B
121W	FL38501	14000	5000K	80+	93%	268,000	Bronze	0.36	0.27	400W	FA-120C5B
212W	FL23526*	24294	4000K	80+	93%	258,000	Bronze	0.63	0.46	1000W	FA-212N5B
212W	FL46228	24640	5000K	80+	93%	258,000	Bronze	0.63	0.46	1000W	FA-212C5B

## V-Flood

\* Contact for lead time

† Lumen maintenance data is based on LED testing per IESNA LM-80-08 and projected per IESNA TM-21-11

## Benefits and Features

- Rugged die cast housing with a durable powder coat finish
- Vandal resistant polycarbonate lens
- Twist lock photocell receptacle and shorting cap included with the fixture.
- Operating temperature range of -40° C to 40° C
- 10KA surge protection
- DesignLights Consortium® (DLC) qualified
- 5 year warranty
- 0-10V DC dimming standard to maximize energy savings

## Photometrics

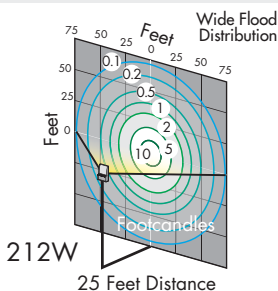
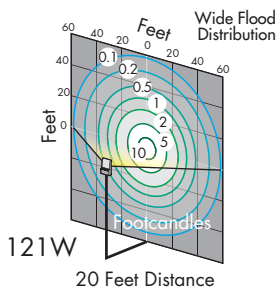

## Dimensions

121W  
Weight: 13.1 lbs (1.19 kg)

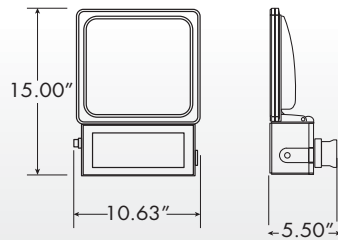

212W  
Weight: 21.8 lbs (9.88 kg)

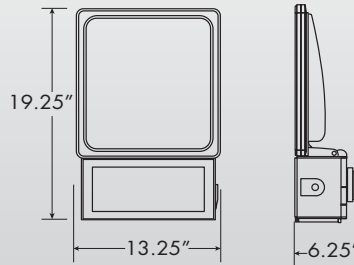

## Accessories (Order as separate line items)

- FL64171 U-Bracket for 121W flood
- FL99436 U-Bracket for 212W flood
- FL22402 6" straight arm for square pole, bronze
- FL26815 6" straight arm, 4" dia/ round pole, bronze
- FL25107 Slipfitter fits into 2-3/8" mast arm (tenon)
- PH12415 Twist lock photocell (120-277V)
- PH81156 Twist lock photocell (480V)
- PH87145 Twist lock photocell (347V)
- PH81975 Twist lock shorting cap, replacement
- BSP3-277-LC 10KA surge protector



# LED AREA LIGHTING

## Dusk to Dawn

Wattage	Order Code	Lumen Output	Color Temp.	CRI	Lumen Maint. @50,000 hours <sup>†</sup>	Calc. L70@25°C Amb.(hrs) <sup>†</sup>	Fixture Color	Amp. Draw (A) 120V 277V	Replaces Existing Wattages	DLC Model Number
40W	SL16543	4100	5000K	74	96%	380,000	Gray	0.35 0.16	100W MH/175W MV	SL3-040CA

<sup>†</sup> Lumen maintenance data is based on LED testing per IESNA LM-80-08 and projected per IESNA TM-21-11

## Benefits and Features

- Rugged die cast housing with a durable powder coat finish
- Low profile, quick and easy upgrade to existing area lighting fixtures
- Twist lock photocell receptacle and photocell included with the fixture
- Optical assembly is sealed with a silicone gasket
- Rated for wet locations
- 120-277V, 50/60 Hz input power
- Long life: 380,000 hours
- 0-10V dimming capability is standard
- Easily install in a wall mount or pole mounting application



Mounting kit, included, contains items shown here



## Photometrics

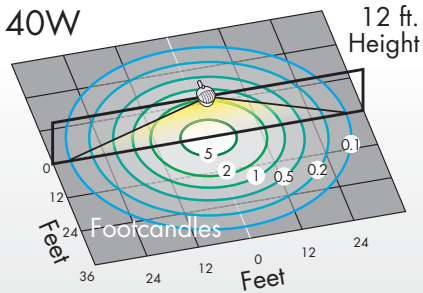

## Dimensions

Weight: 5.2 lbs (2.36 kg)

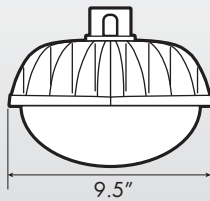
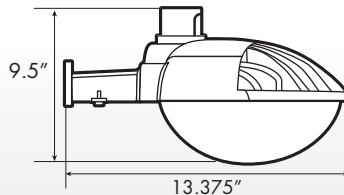

## Accessories (Order as separate line items)

- PH12415 Replacement Twist lock photocell (120-277V)
- PH81975 Twist lock shorting cap



## Environ

Environ is the latest series of LED area lighting fixtures by Venture Lighting. Low profile design featuring long life and low maintenance. Perfect for new construction and easy replacement of existing area lighting fixtures. The robust design paired with a variety of mounting options makes them ideal for locations, such as, retail, parking and street lighting.



### Benefits and Features

- Rugged die cast housing with a durable powder coat finish
- Vandal resistant polycarbonate lens
- Optical chamber is sealed and gasketed
- Capable of adding motion sensor (factory installed)
- Each fixture will be supplied with a 7-pin receptacle and a shorting cap
- Operating temperature range of -40° C to 40° C
- 10kA surge protection
- 5 year warranty
- 80% Energy Savings
- UL Rated for wet locations
- Universal 120-277V 50/60 Hz input or 347-480V input
- 0-10V DC dimming standard to maximize energy savings

### Ordering & Model Number Information

Choose nomenclature that suits application. Example: **ENV-120CT2-ABZ-SHM12**

ENV-	120	C	T2-	A	BZ-	SH	M12
Fixture Type	Wattage	Color Temp.	Optics	Voltage	Fixture Finish	Shield	Options
ENV - Venture's LED Area Fixture	<input type="checkbox"/> 120 - 120W <input type="checkbox"/> 150 - 150W <input type="checkbox"/> 200 - 200W <input type="checkbox"/> 380 - 380W <input type="checkbox"/> 480 - 480W	<input type="checkbox"/> C - 5000K <input type="checkbox"/> N - 4000K*	<input type="checkbox"/> T2 - Type II <input type="checkbox"/> T3 - Type III <input type="checkbox"/> T4 - Type IV <input type="checkbox"/> T5 - Type V <input type="checkbox"/> T5W - Type V Wide†	<input type="checkbox"/> A - 120-277V <input type="checkbox"/> B - 347-480V	<input type="checkbox"/> BZ - Bronze	"Blank" - No backlight shield <input type="checkbox"/> SH - Backlight shield	"Blank" - No motion sensor <input type="checkbox"/> M12 - 120-277V motion sensor <input type="checkbox"/> M34 - 347-480V motion sensor

Notes: \* = Contact for lead time; † = 380W/480W only



# LED AREA LIGHTING

## Environ

Wattage	Lumen Output	Color Temp.	CRI	Lumen Maint. @50,000 hours <sup>†</sup>	Calc. L70@25°C Amb.(hrs) <sup>†</sup>	Fixture EPA	Color	Amperage Draw (A)				Replaces Existing HID Wattages
								120V	277V	347V	480V	
120W	13020	4000K	70	99%	>500,000	1.56	Bronze	1.00	0.44	0.33	0.24	175W V, 250W H
120W	13560	5000K	70+	99%	>500,000	1.56	Bronze	1.00	0.44	0.33	0.24	175W V, 250W H
150W	17960	4000K	70	99%	>500,000	1.73	Bronze	1.30	0.55	0.41	0.30	250W V, 400W H
150W	18240	5000K	70+	99%	>500,000	1.73	Bronze	1.30	0.55	0.41	0.30	250W V, 400W H
200W	25400	4000K	70	99%	>500,000	2.08	Bronze	1.70	0.73	0.55	0.40	400W V, 1000W H
200W	25690	5000K	70+	99%	>500,000	2.08	Bronze	1.70	0.73	0.55	0.40	400W V, 1000W H

<sup>†</sup> Lumen maintenance data is based on LED testing per IESNA LM-80-08 and projected per IESNA TM-21-11



200W Environ



### Photometrics

150W

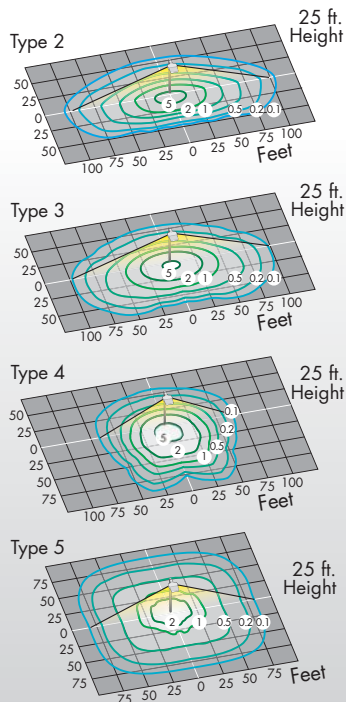

### Dimensions

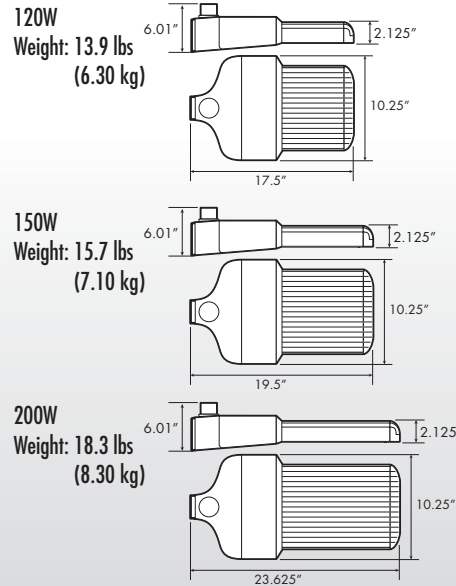

### Accessories (Order as separate line items)

- EN14178 Round pole straight arm - bronze
- EN26814 Square pole mount - bronze
- EN35512 Adjustable slipfitter - bronze
- EN38419 Mast arm (Horizontal tenon) - bronze
- EN47832 Wall mount - bronze
- PH12415 3-Pin Twist lock photocell (120-277V)
- PH81156 3-Pin Twist lock photocell (480V)
- PH87145 3-Pin Twist lock photocell (347V)
- PH81975 Replacement shorting cap
- BSP3-277-LC 10KA surge protector



## High Watt Environ



Wattage	Lumen Output	Color Temp.	CRI	Lumen Maint. @50,000 hours <sup>f</sup>	Calc. L70@25°C Amb.(hrs) <sup>f</sup>	Fixture EPA	Color	Amperage Draw (A)				Replaces Existing HID Wattages
								120V	277V	347V	480V	
380W	41100	4000K	70	89%	>162,000	1.8	Bronze	3.10	1.80	1.60	1.40	1000W V, 1000W H
380W	42660	5000K	70+	89%	>162,000	1.8	Bronze	3.10	1.80	1.60	1.40	1000W V, 1000W H
480W	51800	4000K	70	89%	>162,000	1.95	Bronze	4.00	2.30	2.10	1.70	1000W V, 1000W H
480W	54260	5000K	70+	89%	>162,000	1.95	Bronze	4.00	2.30	2.10	1.70	1000W V, 1000W H

<sup>f</sup> Lumen maintenance data is based on LED testing per IESNA LM-80-08 and projected per IESNA TM-21-11



### Benefits and Features

- Available in 3 different distribution types: Type-3, Type=4 and Type=5 Wide
- Replace 1000W HID with 380W LED

### Dimensions

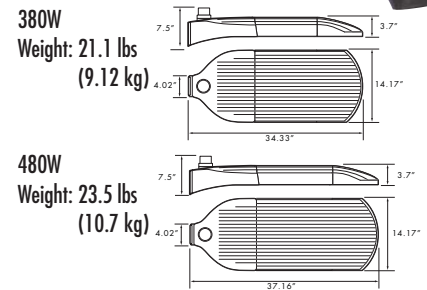

### Photometrics

#### 380W

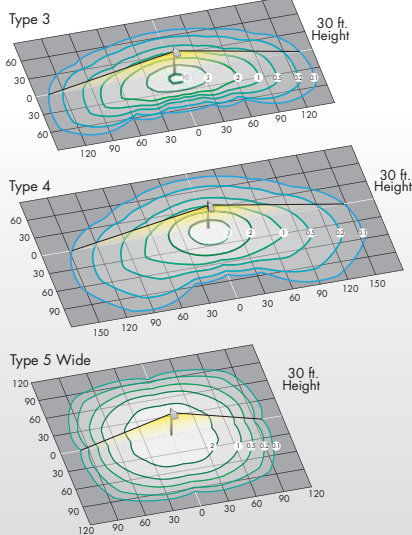

### Photometrics

#### 480W

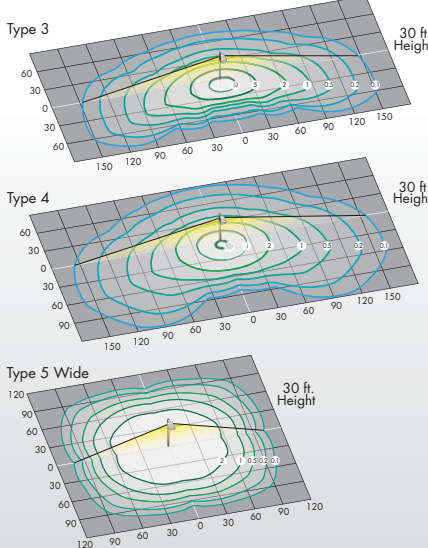

### Accessories (Order as separate line items)

- EN14628 Round pole straight arm - bronze
- EN27395 Square pole mount - bronze
- EN36717 Adjustable slipfitter - bronze
- EN38159 Mast arm (Horizontal tenon) - bronze
- EN47832 Wall mount - bronze
- PH12415 3-Pin Twist lock photocell (120-277V)
- PH81156 3-Pin Twist lock photocell (480V)
- PH87145 3-Pin Twist lock photocell (347V)
- PH81975 Replacement shorting cap
- BSP3-277-LC 10KA surge protector



# LED SURFACE MOUNT CANOPY LIGHTING

## Breezeway

Wattage	Order Code	Lumen Output	Color Temp.	CRI	Lumen Maint. @50,000 hours <sup>†</sup>	Calc. L70@25°C Amb.(hrs) <sup>†</sup>	Fixture Color	Amp. Draw (A)		Replaces Existing HID Wattages	DLC Model Number
								120V	277V		
23W	CP71667	2696	5000K	70+	98%	>500,000	White	0.21	0.09	70W	CPA-020C-ND
41W	CP91141	4498	5000K	70+	98%	>500,000	White	0.35	0.16	100W	CPA-043C-ND
54W	CP87385	6161	5000K	70+	98%	>500,000	White	0.46	0.22	175W	CPA-054C-ND
72W	CP25052	8364	5000K	70+	97%	>500,000	White	0.61	0.27	250W	CPA-072C-ND

## Fairway low glare

Wattage	Order Code	Lumen Output	Color Temp.	CRI	Lumen Maint. @50,000 hours <sup>†</sup>	Calc. L70@25°C Amb.(hrs) <sup>†</sup>	Fixture Color	Amp. Draw (A)		Replaces Existing HID Wattages	DLC Model Number
								120V	277V		
40W	CP55068	4730	5000K	70+	91%	219,000	White	0.34	0.16	100W	CPF-1005C

<sup>†</sup> Lumen maintenance data is based on LED testing per IESNA LM-80-08 and projected per IESNA TM-21-11

## Benefits and Features

- Heavy-duty aluminum housing with a durable powder coat finish
- High-performance, UV stabilized acrylic optics
- Optical chamber is sealed and gasketed
- Operating temperature range of -40° C to 40° C
- 10KA surge protection
- DesignLights Consortium® (DLC) qualified
- Up to 76% Energy Savings
- Rated for wet locations
- Low glare lens provides optimal coverage and is more appealing for pedestrians
- Universal 120-277V 50/60 Hz input
- 0-10V DC dimming standard to maximize energy savings

## Photometrics

### Breezeway

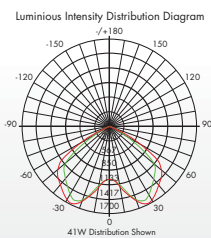

### Fairway

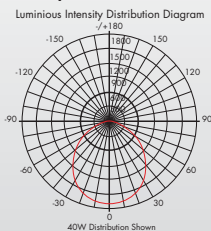

## Dimensions

**Breezeway**  
Weight: 6.8 lbs (3.08 kg)

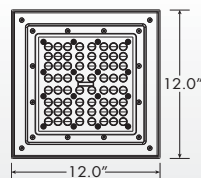

**Fairway**  
Weight: 5.0 lbs (2.27 kg)

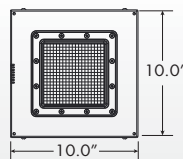



# LED SURFACE MOUNT CANOPY LIGHTING

## Pavilion



Wattage	Order Code	Lumen Output	Color Temp.	CRI	Lumen Maint. @50,000 hours†	Calc. L70@25°C Amb.(hrs)†	Fixture Color	Amp. Draw (A)		Replaces Existing HID Wattages	DLC Model Number
45W	CP42239	4532	5000K	80+	94%	319,000	Bronze	0.39	0.17	175W	CPE-45CA
82W	CP58419	9325	5000K	80+	93%	293,000	Bronze	0.70	0.31	250W	CPE-82CA

† Lumen maintenance data is based on LED testing per IESNA LM-80-08 and projected per IESNA TM-21-11

### Benefits and Features

- Benefits and Features
- Rugged die cast housing with a durable powder coat finish
- Button photocell ready
- Optical chamber is sealed and gasketed
- Vandal resistant polycarbonate lens
- Operating temperature range of -40° C to 40° C
- 10KA surge protection
- DesignLights Consortium® (DLC) qualified
- 5 year warranty
- 80% Energy Savings
- UL Rated for wet locations
- Universal 120-277V 50/60 Hz input
- 0-10V DC dimming standard to maximize energy savings
- Can be surface or pendant mounted

### Photometrics

45W 10 ft. Height

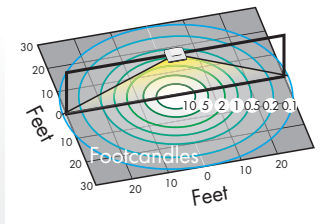

82W 15 ft. Height

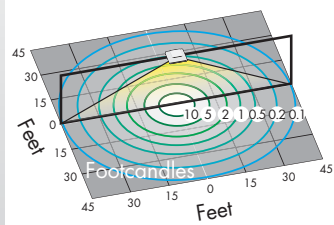

### Dimensions

45W  
Weight: 6.1 lbs (2.77 kg)

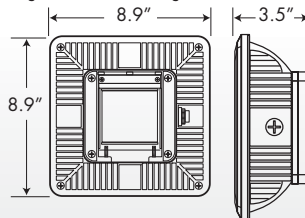

82W  
Weight: 12.4 lbs (5.62 kg)

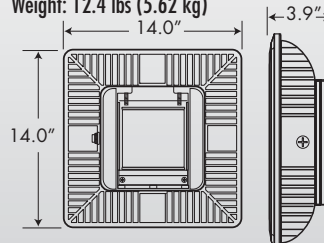

### Accessories (Order as separate line items)

- PH56903 Button Photocell (120-277V)



# LED CANOPY LIGHTING

## Gas Station Canopy

Wattage	Order Code	Lumen Output	Color Temp.	CRI	Lumen Maint. @50,000 hours <sup>†</sup>	Calc. L70@25°C Amb.(hrs) <sup>†</sup>	Fixture Color	Amp. Draw (A)		Replaces Existing HID Wattages	DLC Model Number
								120V	277V		
150W	CP62135*	19100	4000K	80+	93%	216,000	White	1.30	0.56	400W	CPT-150NFA1
150W	CP51419	19500	5000K	80+	93%	216,000	White	1.30	0.56	400W	CPT-150CFA1

\* Contact for lead time

† Lumen maintenance data is based on LED testing per IESNA LM-80-08 and projected per IESNA TM-21-11

### Benefits and Features

- Constructed from heavy-duty aluminum
- Designed for surface mounting
- Low profile, lightweight design
- Vandal resistant polycarbonate lens
- Operating temperature range of -40° C to 40° C
- DesignLights Consortium® (DLC) qualified
- 5 year warranty
- UL Rated for wet locations



### Photometrics

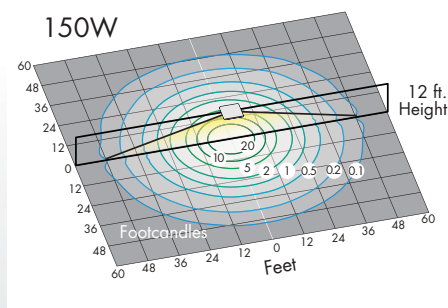

### Dimensions

Weight: 14.5 lbs (6.58 kg)

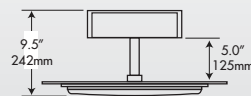
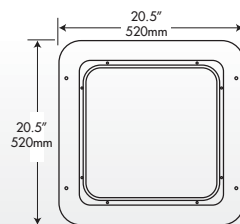

# LED RECESSED CANOPY LIGHTING

## Cascade



Wattage	Order Code	Lumen Output	Color Temp.	CRI	Lumen Maint. @50,000 hours†	Calc. L70@25°C Amb.(hrs)†	Fixture Color	Amp. Draw (A) 120V	Amp. Draw (A) 277V	Replaces Existing HID Wattages	DLC Model Number
23W	CP47526*	2670	4000K	70	98%	>500,000	White	0.21	0.09	70W	CPC-03N-25NDA-xxAC01
23W	CP82401	2696	5000K	70+	98%	>500,000	White	0.21	0.09	70W	CPC-03C-25NDA-xxAC01
41W	CP43127*	4810	4000K	70	98%	>500,000	White	0.35	0.16	100W	CPC-03N-45NDA-xxAC01
41W	CP92745	4498	5000K	70+	98%	>500,000	White	0.35	0.16	100W	CPC-03C-45NDA-xxAC01
54W	CP74135*	6580	4000K	70	98%	>500,000	White	0.46	0.22	175W	CPC-03N-60NDA-xxAC01
54W	CP48715	6161	5000K	70+	98%	>500,000	White	0.46	0.22	175W	CPC-03C-60NDA-xxAC01
72W	CP62528*	8940	4000K	70	97%	>500,000	White	0.61	0.27	250W	CPC-03N-80NDA-xxAC01
72W	CP36619	8364	5000K	70+	97%	>500,000	White	0.61	0.27	250W	CPC-03C-80NDA-xxAC01

\* Contact for lead time

† Lumen maintenance data is based on LED testing per IESNA LM-80-08 and projected per IESNA TM-21-11

## Benefits and Features

- Heavy-duty aluminum housing with a durable powder coat finish
- High-performance, UV stabilized acrylic optics
- Optical chamber is sealed and gasketed
- Operating temperature range of -40° C to 40° C
- 10KA surge protection
- DesignLights Consortium® (DLC) qualified
- 5 year warranty
- Up to 76% Energy Savings
- Universal 120-277V 50/60 Hz input
- 0-10V DC dimming standard to maximize energy savings

## Photometrics

Luminous Intensity Distribution Diagram

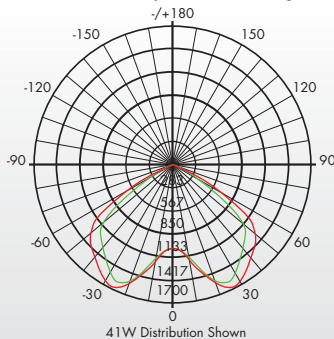

## Dimensions

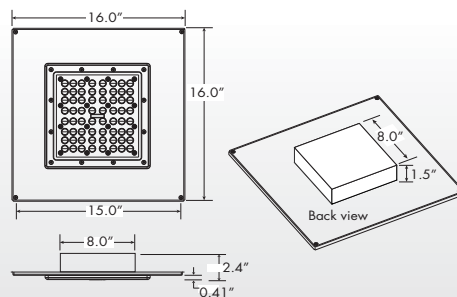

# LED PARKING GARAGE

## Parkway without sensor

Wattage	Order Code	Lumen Output	Color Temp.	CRI	Lumen Maint. @50,000 hours <sup>†</sup>	Calc. L70@25°C Amb.(hrs) <sup>†</sup>	Fixture Color	Amp. Draw (A) 120V 277V	Replaces Existing HID Wattages	DLC Model Number
41W	CP45021	4576	5000K	70+	98%	>500,000	White	0.35 0.16	100W	CPA-043C-WD
54W	CP54776	6142	5000K	70+	98%	>500,000	White	0.46 0.22	175W	CPA-054C-WD
72W	CP86738	8126	5000K	70+	97%	>500,000	White	0.61 0.27	250W	CPA-072C-WD

## Greenway with sensor

Wattage	Order Code	Lumen Output	Color Temp.	CRI	Lumen Maint. @50,000 hours <sup>†</sup>	Calc. L70@25°C Amb.(hrs) <sup>†</sup>	Fixture Color	Amp. Draw (A) 120V 277V	Replaces Existing HID Wattages	DLC Model Number
41W	CP97593	4576	5000K	70+	98%	>500,000	White	0.35 0.16	100W	CPB-3602C-WD01
54W	CP38074	6142	5000K	70+	98%	>500,000	White	0.46 0.22	175W	CPB-4802C-WD01
72W	CP96209	8126	5000K	70+	97%	>500,000	White	0.61 0.27	250W	CPB-6402C-WD01

<sup>†</sup> Lumen maintenance data is based on LED testing per IESNA LM-80-08 and projected per IESNA TM-21-11

## Benefits and Features

- Heavy-duty aluminum housing with a durable powder coat finish
- Occupancy and daylight sensor pre-installed
- High-performance, UV stabilized acrylic optics
- Optical chamber is sealed and gasketed
- Operating temperature range of -40° C to 40° C
- 10KA surge protection
- DesignLights Consortium® (DLC) qualified
- 5 year warranty
- Up to 76% Energy Savings
- Rated for wet locations
- Universal 120-277V 50/60 Hz input
- 0-10V DC dimming standard to maximize energy savings
- Can be surface or pendant mounted



## Photometrics

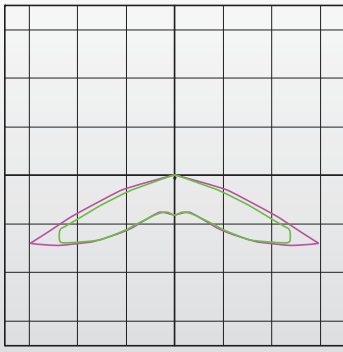

Wide Distribution\*

Max 60° H  
0° H  
90° H



## Dimensions

Parkway  
Without Sensor  
Weight: 6.8 lbs (3.08 kg)

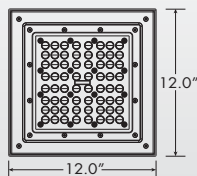

Greenway  
With Sensor  
Weight: 7.5 lbs (3.40 kg)

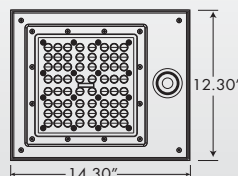

## Accessories (Order as separate line items)

- PH46224 Wireless program tool

# LED PARKING GARAGE



NOTE: shown with PH41817 motion sensor ordered separately

## Parking Garage

Wattage	Order Code	Lumen Output	Color Temp.	CRI	Lumen Maint. @50,000 hours†	Calc. L70@25°C Amb.(hrs)†	Fixture Color	Amp. Draw (A) 120V	Amp. Draw (A) 277V	Replaces Existing HID Wattages	Model Number
44W	CP16416*	4470	4000K	75	87%	134,000	Bronze	0.38	0.17	175W	CPV-35NA
44W	CP52347	4500	5000K	75+	87%	134,000	Bronze	0.38	0.17	175W	CPV-35CA
84W	CP13491*	8330	4000K	75	87%	129,000	Bronze	0.71	0.32	250W	CPV-84NA
84W	CP48164	8300	5000K	75+	87%	129,000	Bronze	0.71	0.32	250W	CPV-84CA

\* Contact for lead time

† Lumen maintenance data is based on LED testing per IESNA LM-80-08 and projected per IESNA TM-21-11

## Benefits and Features

- Heavy-duty aluminum housing with a durable powder coat finish
- High-performance, UV stabilized acrylic optics
- Optical chamber is sealed and gasketed
- Operating temperature range of -40° C to 40° C
- 10KA surge protection
- DesignLights Consortium® (DLC) qualified
- 5 year warranty
- Up to 76% Energy Savings
- Universal 120-277V 50/60 Hz input
- 0-10V DC dimming standard to maximize energy savings

## Photometrics

44W

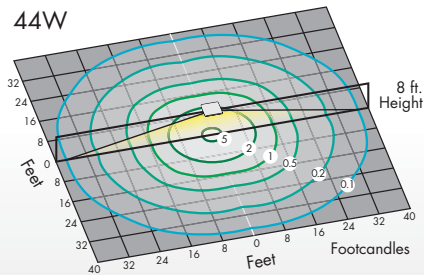

84W

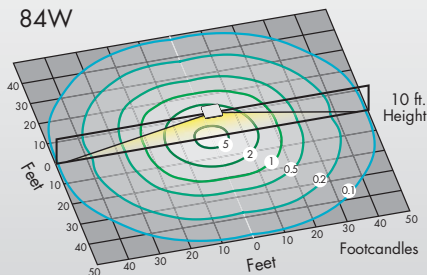

## Dimensions

44W: Weight: 10 lbs (4.54 kg)

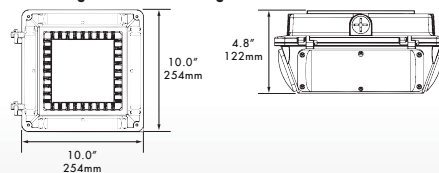

84W: Weight: 21 lbs (9.53 kg)

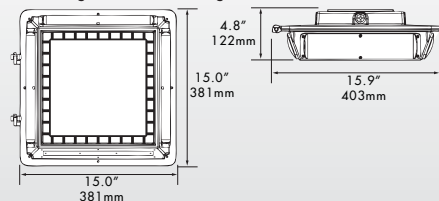

## Accessories (Order as separate line items)

- PH46224 Wireless program tool
- PH41817 Motion/Dim/Photocell Sensor
- LN18673 Sensor lens for garage (low mounting height) applications





Take Control of Your Lighting with Venture Lighting's

## LeafNut® for Outdoor

Venture's LeafNut® system is an advanced intelligent wireless control system for area and street lighting. The LeafNut "nodes" are housed in each light fixture and communicate via radio, satellite and cellular systems to deliver control and status messages to a secure web page accessed from any web based computer. You can control, adjust, monitor and receive maintenance messages from each light fixture. With an upgrade kit of energy efficient pulse start ballasts and Uni-Form® lamps plus the power of the LeafNut system, you can drastically reduce your energy consumption expenses while improving with bright, white site lighting.



### Components

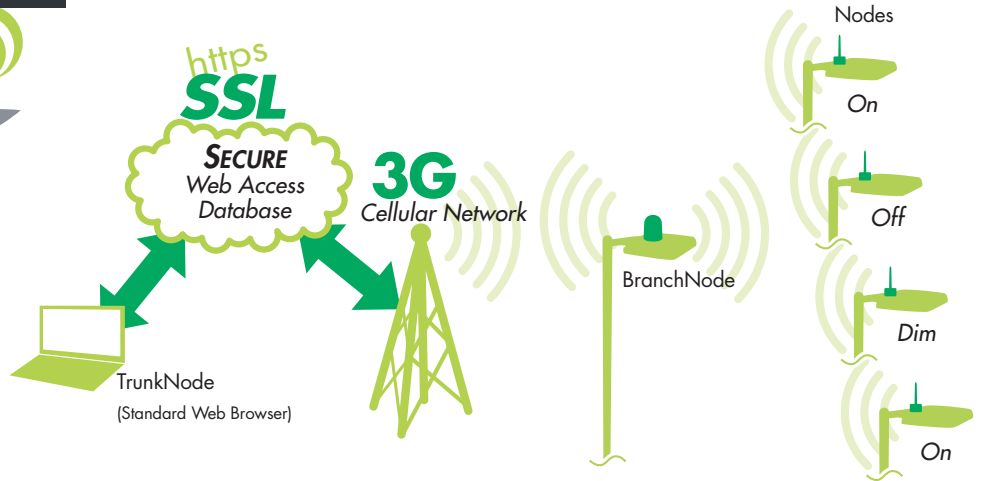

INGENIOUS CONTROL

## EyeNut for Indoor

EyeNut is a unique web-based, wireless control, monitoring and management system for indoor lighting. It gives users the freedom to commission, configure and completely control their own lighting to maximize energy savings and reduce carbon emissions.

Installation and initial configuration is simple and controls can be altered at the touch of a button to meet a building's changing needs. Comparisons with existing technology are impressive; it is capable of controlling 500 EyeNut devices from one wireless gateway compared to DALI's 64. EyeNut will also allow connection to Building Management Systems and enable a variety of control strategies to be employed, for example daylight harvesting, occupancy sensing, time scheduling, and scene setting.

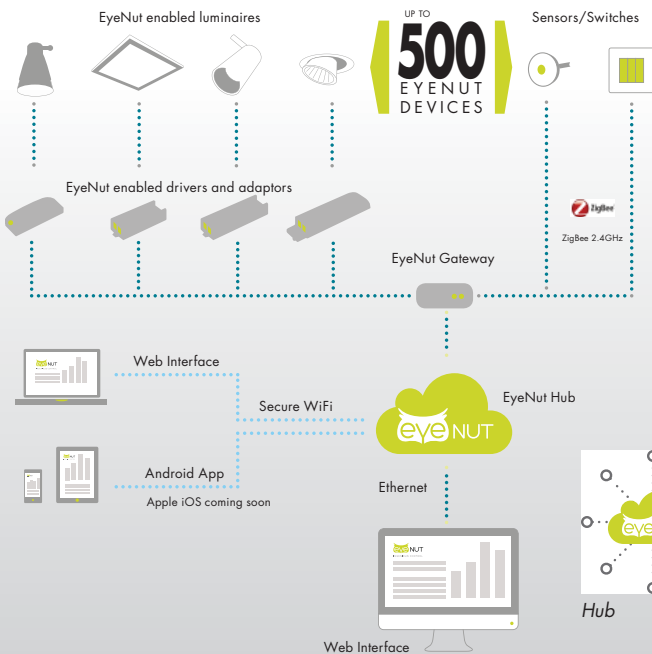

### Components



# LED RETROFIT LAMPS



## Medium and Mogul Base Lamps

Wattage	Order Code	Base Type	Lumen Output	Color Temperature	CRI	Rated Life (hrs)	Beam Angle	Power Factor	THD	Replaces Existing HID Wattages
8W	LP15229	E26	960	4000K	80	50,000	360°	>0.90	<20%	50
10W	LP88549	E26	1200	4000K	80	50,000	360°	>0.90	<20%	50
14W	LP96356	E26	1680	4000K	80	50,000	360°	>0.90	<20%	70
18W	LP27843	E26	2160	4000K	80	50,000	360°	>0.90	<20%	100
22W	LP76418	E26	2640	4000K	80	50,000	360°	>0.90	<20%	175
27W	LP66419	E26	3240	4000K	80	50,000	360°	>0.90	<20%	175
27W	LP34559	E39	3240	4000K	80	50,000	360°	>0.90	<20%	175
27W	LP26134	E26	3240	5000K	80	50,000	360°	>0.90	<20%	175
27W	LP52712	E39	3240	5000K	80	50,000	360°	>0.90	<20%	175
36W	LP12893	E26	4320	4000K	80	50,000	360°	>0.90	<20%	175
36W	LP23748	E39	4320	4000K	80	50,000	360°	>0.90	<20%	175
36W	LP16524	E26	4320	5000K	80	50,000	360°	>0.90	<20%	175
36W	LP16981	E39	4320	5000K	80	50,000	360°	>0.90	<20%	175
45W	LP79493	E26	5400	4000K	80	50,000	360°	>0.90	<20%	175
45W	LP48460	E39	5400	4000K	80	50,000	360°	>0.90	<20%	175
45W	LP16844	E26	5400	5000K	80	50,000	360°	>0.90	<20%	175
45W	LP26126	E39	5400	5000K	80	50,000	360°	>0.90	<20%	175
54W	LP62668	E26	6500	4000K	80	50,000	360°	>0.90	<20%	250
54W	LP85756	E39	6500	4000K	80	50,000	360°	>0.90	<20%	250
54W	LP34156	E26	6500	5000K	80	50,000	360°	>0.90	<20%	250
54W	LP48412	E39	6500	5000K	80	50,000	360°	>0.90	<20%	250
100W	LP28509	E39	11,000	4000K	80	50,000	360°	>0.90	<20%	400
100W	LP28192	E39	11,000	5000K	80	50,000	360°	>0.90	<20%	400



### Benefits and Features

- Up to 5 times longer life and 80% energy savings compared to 50W through 400W metal halide lamps
- Improved reliability and reduced maintenance costs
- Universal Burn Position - Omnidirectional (base-up/base-down/horizontal operation)
- Easy installation, standard E26 and E39 bases available
- 5 year warranty
- Integrated driver

### Dimensions

Wattage	A (in)	B (in)
8	4.84	2.36
10	5.63	2.36
14	5.75	2.76
18	6.54	2.76
22	7.32	2.76
27	8.07	3.66
36	9.25	3.66
45	10.13	3.66
54	10.13	3.66
100	11.42	4.91

### Wiring

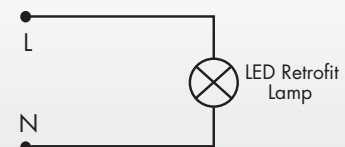

Easy to install - bypass ballast and provide voltage directly to lamp

### Accessories (Order as separate line items)

- BSP3-277-LC 10KA surge protector



# SPECIALTY LED RETROFIT LAMPS

## Directional Mogul Base Lamps

Wattage	Order Code	Base Type	Lumen Output	Color Temperature	CRI	Rated Life (hrs)	Distribution	Beam Angle	Power Factor	THD	Model Number
54W	LP27189	E39	6500	5000K	70	50,000	Type V	180°	>0.90	<20%	HR-54T5A2-E39AK-5K
115W	LP38561	E39	13500	5000K	70	50,000	Type V	180°	>0.90	<20%	HR-115T5A2-E39AK-5K



### Photometrics

54W Type 5 Distribution

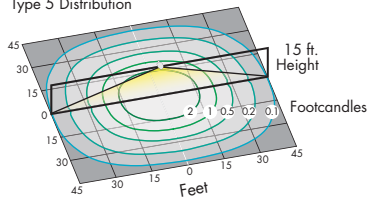

115W Type 5 Distribution

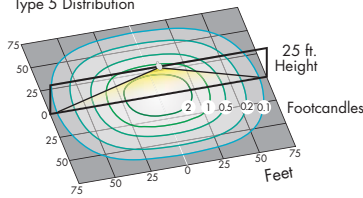

### Dimensions

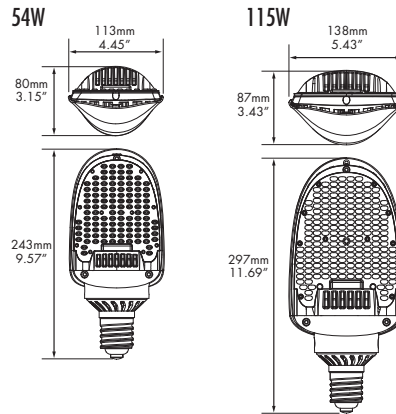

### Wiring

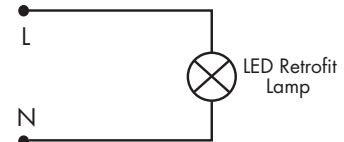

Easy to install - bypass ballast and provide voltage directly to lamp

### Accessories (Order as separate line items)

- BSP3-277-LC 10KA surge protector



## Lowbay - Mogul Base Retrofit Lamp

Wattage	Order Code	Base Type	Lumen Output	Color Temperature	CRI	Rated Life (hrs)	Beam Angle	Power Factor	THD	Model Number
40W	LP27198	EX39	4800	4000K	80	50,000	360°	>0.90	<20%	OR-040AA-EX39-4K



### Photometrics

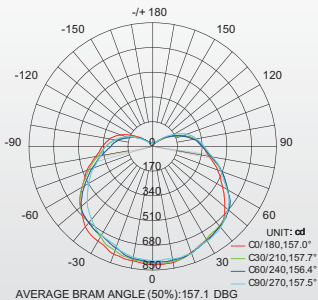

### Dimensions

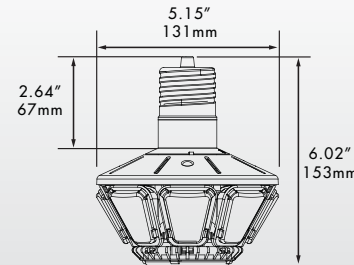

### Wiring

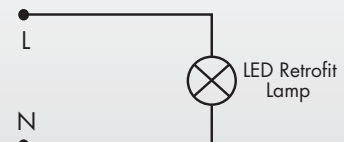

Easy to install - bypass ballast and provide voltage directly to lamp

### Accessories (Order as separate line items)

- BSP3-277-LC 10KA surge protector

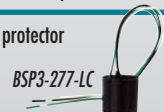



# LED T8 LAMPS

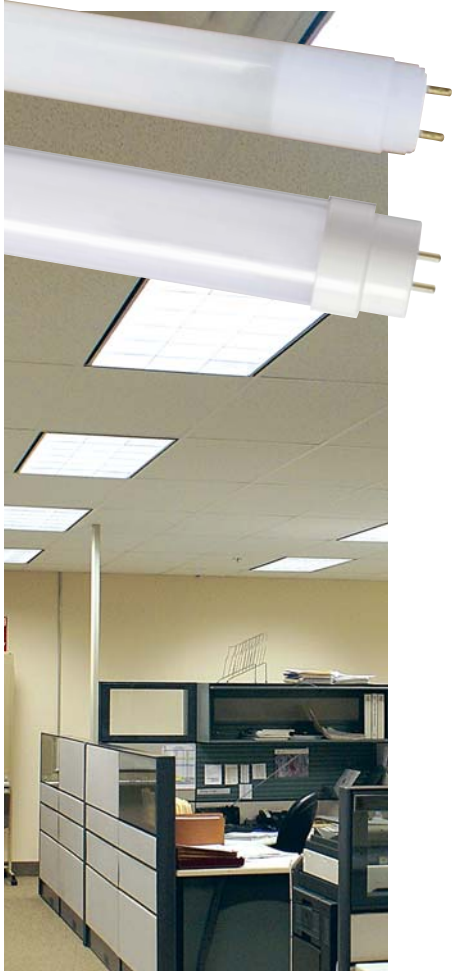

## Fluorescent Ballast Bypass Ballast-free

Wattage	Order Code	T8 Lamp Length	Lumen Output	Color Temperature	CRI	Rated Life (hrs)	Replaces Existing Fluorescent Wattages	DLC Model Number
8	LP26198*	2ft.	950	4000K	80	50,000	15W	T080802NAA01
9	LP19567	2ft.	925	5000K	80	50,000	15W	VL1-T080090250AA01
15	LP41274*	4ft.	1800	4000K	80	50,000	28W - 32W	T081504NAA01
18	LP98237	4ft.	2000	3000K	80	50,000	28W - 32W	VL1-T080180430AA02
18	LP88632	4ft.	2000	4000K	80	50,000	28W - 32W	VL1-T080180440AA02
18	LP90501	4ft.	2000	5000K	80	50,000	28W - 32W	VL1-T080180450AA02

Note: Directly wire to 120-277V input.

\* Contact for lead time

## Fluorescent Ballast Compatible<sup>†</sup> Direct Replacement

Wattage	Order Code	T8 Lamp Length	Lumen Output	Color Temperature	CRI	Rated Life (hrs)	Replaces Existing Fluorescent Wattages	DLC Model Number
17W	LP16519	4ft.	1926	4000K	80	50,000	28W - 32W	VL1-T8IS17-0440-AA00
17W	LP26884	4ft.	1926	5000K	80	50,000	28W - 32W	VL1-T8IS17-0450-AA00

Note: <sup>†</sup> Instant start ballast only

## All Fit, Direct or Bypass

Wattage	Order Code	T8 Lamp Length	Lumen Output	Color Temperature	CRI	Rated Life (hrs)	Replaces Existing Fluorescent Wattages	DLC Model Number
18W	LP71263	4ft.	2212	4000K	80	50,000	28W - 32W	VL1-T8UNV18-0440-AI00

Note: All Fit lamps are Instant start, Programmable and Rapid Start ballast compatible and can also be wired directly to 120-277V by bypassing fluorescent ballast.

### Benefits and Features

- 5 year warranty
- Reduces energy up to 50%
- 2-3 times the life of traditional fluorescent lamps
- Free of IR and UV emissions
- Instant-on with full light output and stable lamp to lamp color

### Dimensions

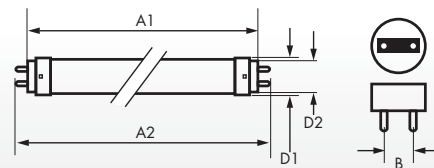

Wattage	A1 (in)	A2 (in)	B (in)	D1 (in)	D2 (in)
8/9	23.18	23.74	0.51	1.01	1.08
15/17/18	47.24	47.72	0.51	1.01	1.08

Base: G13 medium bi-pin

### Accessories (Order as separate line items)

- 7300-001K Non-Shunted G13 Socket - 50pc Kit



# HIGH INTENSITY DISCHARGE LIGHTING SOLUTIONS



Super Pulse Start Long Life (SPL) Lamps

# HID METAL HALIDE LAMPS



## Standard and Pulse Start Lamps

Watts	Order Code	Product Description	ANSI Code	Case Pack
50	32100	MP 50W/U/UVS/PS	M110/O	12
	52312	MH 50W/U/PS	M110/E	12
70	40389	MP 70W/U/UVS/PS	M98/O	12
	78138	MH 70W/U/PS	M98/E	12
100	96267	MP 100W/U/UVS/PS	M90/O	12
	27266	MH 100W/U/PS	M90/E	12
	67868	MH 100W/U/ED28/PS	M90/E	12
150	22455	MP 150W/U/UVS/PS/740	M102/O	12
	99584	MH 150W/U/PS/740	M102/E	12
	13556	MH 150W/U/ED28/PS/740	M102/E	12
175	29145	MH 175W/U/PS/740	M152/E	12
	35281	MH 175W/C/U/PS/737	M152/E	12
	16497	MS 175W/BU/MED/PS/740	M152/E	12
	68475	MS 175W/BU/PS/740	M152/E	12
	88791	MH 175W/U	M57/E	12
	15556	MH 175W/U/MED	M57/E	12
	63187	MH 175W/C/U/MED	M57/E	12
	200	60811	MS 200W/BU/MED/PS/740	M136/E
250	25028	MP 250W/U/UVS/PS/740	M153/O	12
	25029	MP 250W/C/U/UVS/PS/737	M153/O	12
	37517	MH 250W/U/PS/740	M153/E	12
	40812	MH 250W/C/U/PS/737	M153/E	12
	49621	MS 250W/V/PS/740	M153/E	12
	81054	MS 250W/H75/PS/740	M153/E	12
	63052	MH 250W/U	M58/E	12
	61290	MH 250W/C/U	M58/E	12
	33479	MH 250W/U/T15	M58/E	12
	320	32028	MP 320W/U/ED28/UVS/PS/740	M154/O
32029		MP 320W/C/U/ED28/UVS/PS/737	M154/O	12
32037		MP 320W/U/ED37/UVS/PS/740	M154/O	6
32039		MP 320W/C/U/ED37/UVS/PS/737	M154/O	6
21714		MP 320W/BU/ED37/UVS/PS/740	M154/O	6
12718		MH 320W/U/ED28/PS/740	M154/E	12
32149		MH 320W/C/U/ED28/PS/737	M154/E	12
21785		MH 320W/U/ED37/PS/740	M154/E	6
41569		MH 320W/C/U/ED37/PS/737	M154/E	6
59194		MS 320W/V/ED28/PS/740	M154/E	12
57626		MS 320W/H75/T15/S/PS/740	M154/E	12
79710		MS 320W/H75/T15/L/PS/740	M154/E	12

Watts	Order Code	Product Description	ANSI Code	Case Pack
400	40020	MP 400W/U/ED28/UVS/PS/740	M155/O	12
	40022	MP 400W/C/U/ED28/UVS/PS/737	M155/O	12
	40037	MP 400W/U/UVS/PS/740	M155/O	6
	40039	MP 400W/C/U/UVS/PS/737	M155/O	6
	71642	MP 400W/V/UVS/PS/740	M155/O	6
	45541	MP 400W/C/V/UVS/PS/737	M155/O	6
	95527	MPI 400W/BU	M59/O	6
	26091	MPI 400W/C/BU	M59/O	6
	18520	MH 400W/U	M59/E	6
	57540	MH 400W/U/ED28	M59/E	12
	55422	MH 400W/U/T15	M59/E	12
	19824	MH 400W/U/ED28/PS/740	M155/E	12
	47815	MH 400W/C/U/ED28/PS/737	M155/E	12
	28614	MH 400W/U/PS/740	M155/E	6
	43934	MH 400W/C/U/PS/737	M155/E	6
	875	85260	MS 400W/V/ED28/PS/740	M155/E
73531		MS 400W/V/PS/740	M155/E	6
40124		MS 400W/H75/ED28/PS/740	M155/E	12
58788		MS 400W/H75/PS/740	M155/E	6
58953		MP 875W/BU/BT37/PS/740	M166/O	6
41686		MP 875W/C/BU/BT37/PS/737	M166/O	6
1000	22619	MS 875W/BU/BT37/PS/740	M166/E	6
	35426	MS 875W/BD/BT37/PS/740	M166/E	6
	74892	MS 875W/H75/BT37/PS/740	M166/E	6
	72051	MH 1000W/U	M47/E	6
15332	MH 1000W/U/BT37	M47/E	6	

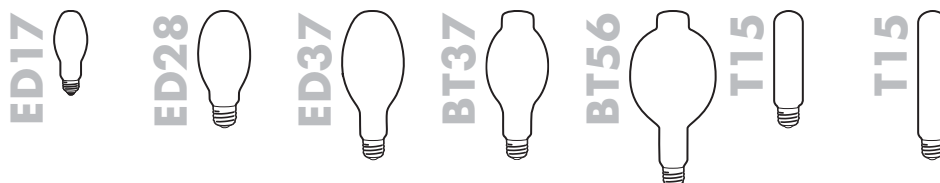

# HID METAL HALIDE BALLASTS AND LAMPS



## Standard and Pulse Start Ballasts Kits

Watts	Order Code	Product Description	ANSI Code
50	V90D5731K	Quad Tap HX-HPF	M110
70	V90D5833K	Quad Tap HX-HPF	M98
100	V90D5932K	Quad Tap HX-HPF	M90
150	V90D7130K	Quad Tap HX-HPF	M102
	V90D7110K	Quad Tap CWA	M102
	V90Y7110TK	480V Tap CWA	M102
175	V90D6112K	Quad Tap CWA	M57
	V90Y6111TK	480V Tap CWA	M57
	V90D7211K	Quad Tap CWA	M152
	V90Y7211TK	480V Tap CWA	M152
250	V90D6211K	Quad Tap CWA (3x4 Core)	M58
	V90Y6211K	480V Tap CWA (3x4 Core)	M58
	V90D6215K	Quad Tap CWA (4x4 Core)	M58
	V90Y6212TK	480V Tap CWA (4x4 Core)	M58
	V90D8412K	Quad Tap CWA	M153
	V90Y8411TK	480V Tap CWA	M153
320	V90D7413K	Quad Tap CWA	M154
	V90Y7412TK	480V Tap CWA	M154
	V90AM7410K	Quint Tap CWA	M154
400	V90D6414K	Quad Tap CWA	M59
	V90Y6413TK	480V Tap CWA	M59
	V90AM6411K	Quint Tap CWA	M59
	V90D7613K	Quad Tap CWA	M155
	V90Y7613TK	480V Tap CWA	M155
	V90AM7610K	Quint Tap CWA	M155
875	V90D8612K	Quad Tap CWA	M166
	V90Y8612TK	480V Tap CWA	M166
	V90AM8610K	Quint Tap CWA	M166
1000	V90D6517K	Quad Tap CWA (4x6 Core)	M47
	V90Y6517TK	480V Tap CWA (4x6 Core)	M47
	V90AM6514K	Quint Tap CWA (4x6 Core)	M47
	V90D7811K	Quad Tap CWA	M141
	V90Y7811TK	480V Tap CWA	M141
	V90AM7810K	Quint Tap CWA	M141

Notes: All ballast kits are sold individually boxed and include prewired capacitor & ignitor (when required) plus universal mounting brackets

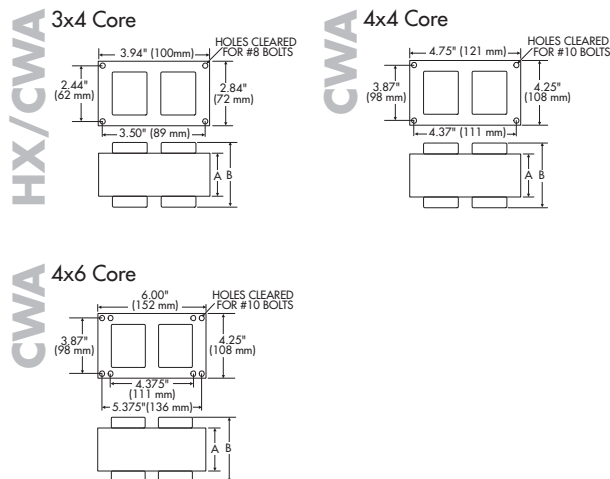

## SUPER PULSE START Long Life Lamps

Watts	Order Code	Product Description	ANSI Code	Case Pack
100	21982	MHL 100W/U/ED17/PS/740	M90/E	12
	22498	MHL 100W/U/ED28/PS/740	M90/E	12
150	35985	MHL 150W/U/ED17/PS/740	M102/E	12
	46105	MHL 150W/U/ED28/PS/740	M102/E	12
250	46895	MHL 250W/V/ED28/PS/740	M153/E	12
	65413	MHL 250W/H75/ED28/PS/740	M153/E	12
320	18635	MHL 320W/V/ED28/PS/740	M154/E	12
	20116	MHL 320W/H75/ED28/PS/740	M154/E	12
	38765	MHL 320W/V/ED37/PS/740	M154/E	6
	28699	MHL 320W/H75/ED37/PS/740	M154/E	6
575	68735	MHL 575W/BU/BT37/PS/740	M178/E	6
	20897	MHL 575W/H75/BT37/PS/740	M178/E	6

## SPL (Long Life) Benefits

- 40,000 hours rated life; up to twice the life of most regular Metal Halide products
- Quartz metal halide
- Excellent maintained lumens with up to 114 LPW
- Ultimate retrofit solution
- Cuts maintenance costs nearly in half, while doubling life and lumen maintenance

## Sports Lamps and Ballasts

Watts	Order Code	Product Description	ANSI Code	Case Pack
1000	47503	MS 1000W/HOR/SPORT60	M47/E	6
	V90D6517K	Quad Tap CWA (4x6 Core)	M47	
	V90Y6517TK	480V Tap CWA (4x6 Core)	M47	
	V90AM6514K	Quint Tap CWA (4x6 Core)	M47	
1500	18360	MH 1500W/HBU	M48/E	6
	12342	MH 1500W/U/XL	M48/E	6
	82070	MS 1500W/HOR/XP/SPORT60	M48/E	6
	V90D6612K	Quad Tap CWA	M48	
	V90Y6612TK	480V Tap CWA	M48	
1650	16419	MS 1650W/HOR/XP/SPORT60	M112/E	6
	V90C6910K	Tri Tap CWA (120/208/240)	M112	
	V90AA6910K	Tri Tap CWA (277/347/480)	M112	

## Benefits

- Brighter - High lumen output
- "Extra Life" lamp available - Venture's MH 1500W/U/XL lamp has a 6000 hour rated life
- Venture's Sports 60 lamps are designed for sports lighting aiming angles
- High lumen output lamps for efficient layout designs
- Good color rendition (65-70 CRI)

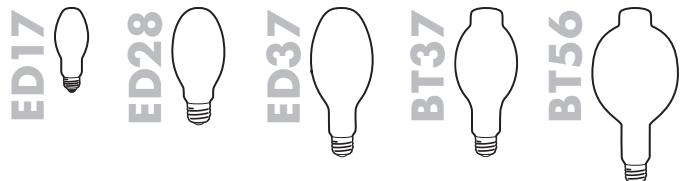

# HID SPECIALIZED METAL HALIDE



## Natural White® PS MH, 5000K, 90+ CRI Lamps

Watts	Order Code	Product Description	ANSI Code	Case Pack
320	95320	MP 320W/H75/T15/S/UVS/PS/EM/950	M154/O	12
	95321	MP 320W/H75/T15/L/UVS/PS/EM/950	M154/O	12
	98530	MP 320W/BU/ED28/UVS/PS/EM/950	M154/O	12
	98520	MP 320W/BU/ED37/UVS/PS/EM/950	M154/O	6
400	57129	MP 400W/BU/UVS/PS/EM/950	M155/O	6
575	95575	MP 575W/BU/BT37/PS/EM/950	M178/O	6
	95577	MS 575W/H75/BT37/PS/EM/950	M178/E	6
775	24983	MP 775W/BU/BT37/PS/950	M181/O	6
	24988	MP 775W/BD/BT37/PS/950	M181/O	6
	24999	MS 775W/H75/BT37/PS/950	M181/E	6

## Natural White® PS MH Ballast Kits

Watts	Order Code	Product Description	ANSI Code	Input Watts
320	V90D7413K	Quad Tap CWA	M154	364
	V90Y7412TK	480V Tap CWA	M154	364
	V90AM7410K	Quint Tap CWA	M154	357
575	V90D5510K	Quad Tap CWA	M178	640
	V90Y5510TK	480V Tap CWA	M178	640
	V90AM5510K	Quint Tap CWA	M178	630
775	V90D9610K	Quad Tap CWA	M181	845
	V90Y9610TK	480V Tap CWA	M181	850
	V90AM9610K	Quint Tap CWA	M181	848

## Energy Master® Energy Saving Retrofit Lamps

Watts	Order Code	Product Description	Replaces Existing Wattage	Watts Saved	ANSI Code	Case Pack
150	44810	MH 150W/U/EM	175W	25	M57/E and M107/E	12
	69559	MH 150W/U/ED28/EM	175W	25	M57/E and M107/E	12
330	91834	MPI 330W/BU/EM	400W	70	M59/O and M155/O	6
360	38029	MPI 360W/BU/EM	400W	40	M59/O and M165/O	6
	67293	MPI 360W/C/BU/EM	400W	40	M59/O and M165/O	6

## White-Lux® Metal Halide Retrofit HPS Lamps

Watts	Order Code	Product Description	ANSI Code	Case Pack
250	91051	MH 250W/U/LU	S50/E	12
	24785	MPI 250W/BU/LU	S50/O	12
400	52134	MH 400W/U/LU	S51/E	6
	59441	MH 400W/U/LU/ED28	S51/E	12
	10044	MPI 400W/BU/LU	S51/O	6

## Natural White® Benefits

- Crisp, bright light with 5000K CCT and 90+ CRI
- 90% maintained lumens (0.90 LLD)
- 14% Perceivable brighter light
- Extreme long life at 15,000 - 40,000 hours

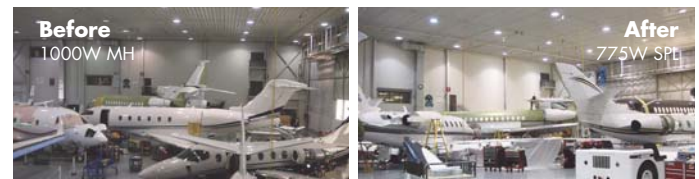
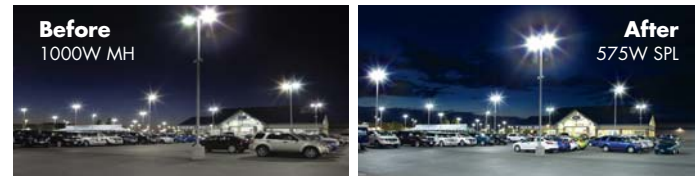

Natural White lamps have an energy saving benefit. They actually run at a lower wattage when operating on magnetic ballasts. This decreases energy costs while still delivering bright, crisp white light.

## Energy Master® Lamps Benefits

- Just change the lamp not the ballast
- Save energy; Up to \$25.50 annually per lamp
- Open rated lamps available in 330W and 360W

## White-Lux® Retrofit Lamps Benefits

- Replace yellow HPS lamps with white MH lamps
- Just change the lamp not the ballast
- Electrical and photometric compatibility with HPS systems
- Clear and coated outer jacket options
- Shrouded open-rated lamps comply with 2005 National Electric Code available in 250 and 400 watts
- Excellent color rendering (65-70 CRI vs. 22 CRI for HPS)

Notes: All ballast kits are sold individually boxed and include prewired capacitor & ignitor (when required) plus universal mounting brackets.

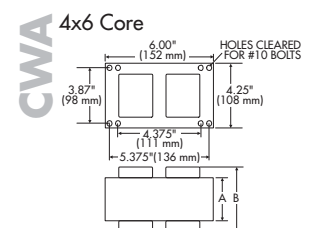

# HID HIGH PRESSURE SODIUM, CAPS AND IGNITORS



## HPS Lamps

Watts	Order Code	Product Description	ANSI Code	Case Pack
50	23002	LU50/MED	S68/E	12
	23010	LU50	S68/E	12
70	23012	LU70	S62/E	12
	23004	LU70/MED	S62/E	12
100	23014	LU100	S54/E	12
	23006	LU100/MED	S54/E	12
150	23016	LU150/55	S55/E	12
	23008	LU150/55/MED	S55/E	12
250	23019	LU250	S50/E	36
400	23022	LU400	S51/E	36
1000	23025	LU1000	S52/E	12

## HPS Ballast Kits

Watts	Order Code	Product Description	ANSI Code
50	V90B1120K	120V Reactor	S68
	V90H1132K	Dual Tap HX-HPF	S68
70	V90B1222K	120V Reactor	S62
	V90D1233K	Quad Tap HX-HPF	S62
100	V90B1322K	120V Reactor	S54
	V90D1333K	Quad Tap HX-HPF	S54
150	V90B1422K	120V Reactor	S55
	V90D1435K	Quad Tap HX-HPF	S55
250	V90D1711K	Quad Tap CWA	S50
	V90Y1711TK	480V Tap CWA	S50
400	V90D1912K	Quad Tap CWA	S51
	V90Y1912TK	480V Tap CWA	S51
1000	V90D2315K	Quad Tap CWA	S52
	V90Y2311TK	480V Tap CWA	S52

## Capacitors

Product Code	Type	Micro-Farads	VAC
ACG033	Dry Film	6	330
ACG310	Dry Film	8	280
ACG279	Dry Film	10	400
ACG321	Dry Film	12	330
ACG303	Dry Film	12.5	330
ACG277	Dry Film	15	400
ACG301	Dry Film	16	330
ACB3270V	Oil Cap	22	525
ACG247	Dry Film	24	400
ACB2200V	Oil Cap	24	480
ACG278	Dry Film	26	400
ACB2640V	Oil Cap	26	525
ACG263	Dry Film	30	280
ACB2560V	Oil Cap	32	525
ACG312	Dry Film	38	330
ACG255	Dry Film	55	300

## Replacement Ignitors

Product Code	Product Description
BVS004A	35-150W HPS REACTOR
BVS005A	200-430W HPS
BVS006A	35-150W HPS
BVS020	875-1000W HPS/PSMH
BVS032	Low Watt PSMH HX
BVS041	Mid Watt PSMH CWA
BVS045	Mid Watt PSMH HX

## Replacement Sockets

Standard medium and mogul enclosed-rated (E26, E39), open-rated (EX26, EX39), and position oriented mogul (EP39) bases are available. Contact Venture Lighting for more information

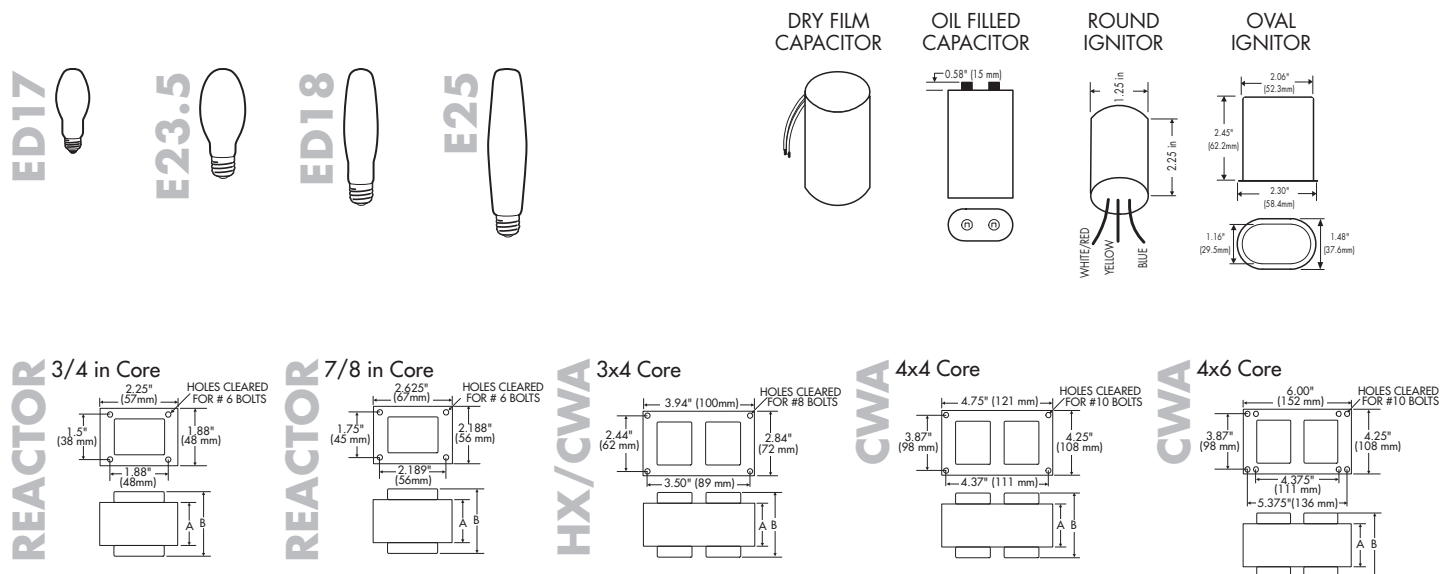

# WARRANTY

## LED Lamps and Retrofit Kits

This Venture lighting product is warranted for the period of 5 years, as specified, from the date of purchase against defects in material and workmanship. The determination of whether the product is defective shall be made by Venture Lighting.

This limited warranty shall only apply if the Venture Lighting product has been installed and operated (i) in compliance with the specifications and guidelines set forth herein, on the product label and packaging, and on the Venture Lighting website, (ii) in accordance with the National

LED Product Type	Rated Life	Warranty Period	Usage
LED T8 Lamps	50,000 hrs	5 years	12 hrs/day annually
LED Retrofit Lamps	50,000 hrs	5 years	12 hrs/day annually
LED Downlight Kits	35,000 hrs	5 years	12 hrs/day annually

Electric Code (NEC), the Standards for Safety of Underwriters' Laboratory, Inc. (UL), the Standards for the American National Standards Association (ANSI), or in Canada, with the standards of the Canadian Standards Association (CSA), and (iii) in lighting equipment designed and approved for the application and in environmental conditions within the normal specified operating range of the product.

This limited warranty does not apply to loss or damage to the product caused by: negligence; abuse; misuse; mishandling; improper installation, storage, or maintenance; damage due to fire or acts of God; vandalism; civil disturbances; power surges; improper power supply; electrical current fluctuations; corrosive environment installations; induced vibration; harmonic oscillation or resonance associated with the movement of air currents around the product; alteration; accident; failure to follow installation, operating, maintenance or environmental instructions.

The warranty terms contained herein shall be the sole and exclusive remedy of the purchaser of Venture Lighting products and state Venture Lighting's entire liability and obligation to such purchaser. NO WARRANTY OF FITNESS FOR ANY SPECIFIC OR PARTICULAR PURPOSE IS MADE OR IS TO BE IMPLIED. NO OTHER WARRANTIES APPLY.

If the product is defective, this product will be repaired or replaced, at Venture Lighting's option. This warranty is expressly limited to the repair or replacement of the product. This warranty gives the customer specific legal rights, which vary from

state to state and province to province. No distributor, salesperson, dealer, retailer or other representative has the authority to change or modify this warranty, wither orally or in writing, in any respect.

WARRANTY IS VOID IF PRODUCT IS NOT USED FOR THE PURPOSE FOR WHICH THIS PRODUCT IS DESIGNED.

## LED Fixtures

This Venture Lighting product is warranted for the period of 5 years, as specified, from the date of purchase against defects in material and workmanship. The determination of whether the product is defective shall be made by Venture Lighting. A Venture Lighting product will not be considered defective under this warranty solely because a small number of separate LED components fail to operate (i.e. provide light) when the number of such failed components is less than 1 0% of the total number of light emitting components which are part of the product.

This limited warranty shall only apply if the Venture Lighting product has been installed and operated (i) in compliance with the specifications and guidelines set forth herein, on the product label and packaging, and on the Venture Lighting website, (ii) in accordance with the National Electric Code (NEC), the Standards for Safety of Underwriters' Laboratory, Inc. (UL), the Standards for the American National Standards Association (ANSI), or in Canada, with the standards of the Canadian Standards Association (CSA), and (iii) in lighting equipment designed and approved for the application and in environmental conditions within the normal specified operating range of the product.

This limited warranty does not apply to loss or damage to the product caused by: negligence; abuse; misuse; mishandling; improper installation, storage, or maintenance; damage due to fire or acts of God; vandalism; civil disturbances; power surges; improper power supply; electrical current fluctuations; corrosive environment installations; induced vibration; harmonic oscillation or resonance associated with the movement of air currents around the product; alteration; accident; failure to follow installation, operating, maintenance or environmental instructions.

The warranty terms contained herein shall be the sole and exclusive remedy of the purchaser of Venture Lighting products and state Venture Lighting's entire liability and obligation to such purchaser. NO WARRANTY OF FITNESS FOR ANY SPECIFIC OR PARTICULAR PURPOSE IS MADE OR IS TO BE IMPLIED. NO OTHER WARRANTIES APPLY.

If the product is defective, this product will be repaired or replaced, at Venture Lighting's option. This warranty is expressly limited to the repair or replacement of the product. This warranty gives the customer specific legal rights, which vary from state to state and province to province. No distributor, salesperson, dealer, retailer or other representative has the authority to change or modify this warranty, wither orally or in writing, in any respect. WARRANTY IS VOID IF PRODUCT IS NOT USED FOR THE PURPOSE FOR WHICH THIS PRODUCT IS DESIGNED.

## Metal Halide Systems

Venture's "One Call" limited warranty program is first in the industry in its comprehensive system coverage. It doubles the warranty period on lamps and ballasts purchased and installed as part of the Uni-Form® pulse start system. Since Venture designs and manufactures the lamps and ballasts, customers who purchase a complete system need to make only "one call" to receive full service on any component from Venture's team of technical experts. This means no finger

pointing; one source, one call to 1-800-451-2606 for service.



Ballasts/Lamps	Product Type	Standard Warranty Period	"One Call" System Warranty
	50W-100W Lamps	One Year	One Year
	150W-875W Lamps	One Year	Two Years
	All SPL Lamps	Two Years	Three Years
	Magnetic Ballasts	Two Years	Five Years



VENTURE<sup>®</sup>  
LIGHTING

# LIGHTING SOLUTIONS

*THE LIGHTING SOLUTIONS YOU NEED,  
WHETHER IT'S **HID** OR **LED***



To place an order, email [Orders@VentureLighting.com](mailto:Orders@VentureLighting.com)

To contact our customer support team, email [CustomerService@VentureLighting.com](mailto:CustomerService@VentureLighting.com)

For general inquiries, email [VLED@VentureLighting.com](mailto:VLED@VentureLighting.com)

Visit [VentureLighting.com](http://VentureLighting.com) to find out more

**(800) 451-2606**

Fax: (800) 451-2605

2451 Enterprise Parkway East

Twinsburg, OH 44087 USA

E-mail: [venture@adlt.com](mailto:venture@adlt.com)

**VentureLighting.com**