

LED RETROFIT LAMPS



54W LED Retrofit lamp



LED RETROFIT LAMPS



Medium and Mogul Base Lamps

Wattage	Order Code	Base Type	Lumen Output	Color Temperature	CRI	Rated Life (hrs)	Beam Angle	Power Factor	THD	Replaces Existing HID Wattages
8W	LP15229	E26	960	4000K	80	50,000	360°	>0.90	<20%	50
10W	LP88549	E26	1200	4000K	80	50,000	360°	>0.90	<20%	50
14W	LP96356	E26	1680	4000K	80	50,000	360°	>0.90	<20%	70
18W	LP27843	E26	2160	4000K	80	50,000	360°	>0.90	<20%	100
22W	LP76418	E26	2640	4000K	80	50,000	360°	>0.90	<20%	175
27W	LP66419	E26	3240	4000K	80	50,000	360°	>0.90	<20%	175
27W	LP34559	E39	3240	4000K	80	50,000	360°	>0.90	<20%	175
27W	LP26134	E26	3240	5000K	80	50,000	360°	>0.90	<20%	175
27W	LP52712	E39	3240	5000K	80	50,000	360°	>0.90	<20%	175
36W	LP12893	E26	4320	4000K	80	50,000	360°	>0.90	<20%	175
36W	LP23748	E39	4320	4000K	80	50,000	360°	>0.90	<20%	175
36W	LP16524	E26	4320	5000K	80	50,000	360°	>0.90	<20%	175
36W	LP16981	E39	4320	5000K	80	50,000	360°	>0.90	<20%	175
45W	LP79493	E26	5400	4000K	80	50,000	360°	>0.90	<20%	175
45W	LP48460	E39	5400	4000K	80	50,000	360°	>0.90	<20%	175
45W	LP16844	E26	5400	5000K	80	50,000	360°	>0.90	<20%	175
45W	LP26126	E39	5400	5000K	80	50,000	360°	>0.90	<20%	175
54W	LP62668	E26	6500	4000K	80	50,000	360°	>0.90	<20%	250
54W	LP85756	E39	6500	4000K	80	50,000	360°	>0.90	<20%	250
54W	LP34156	E26	6500	5000K	80	50,000	360°	>0.90	<20%	250
54W	LP48412	E39	6500	5000K	80	50,000	360°	>0.90	<20%	250
100W	LP28509	E39	11,000	4000K	80	50,000	360°	>0.90	<20%	400
100W	LP28192	E39	11,000	5000K	80	50,000	360°	>0.90	<20%	400



Benefits and Features

- Up to 5 times longer life and 80% energy savings compared to 50W through 400W metal halide lamps
- Improved reliability and reduced maintenance costs
- Universal Burn Position - Omnidirectional (base-up/base-down/horizontal operation)
- Easy installation, standard E26 and E39 bases available
- 5 year warranty
- Integrated driver

Dimensions

Wattage	A (in)	B (in)
8	4.84	2.36
10	5.63	2.36
14	5.75	2.76
18	6.54	2.76
22	7.32	2.76
27	8.07	3.66
36	9.25	3.66
45	10.13	3.66
54	10.13	3.66
100	11.42	4.91

Wiring

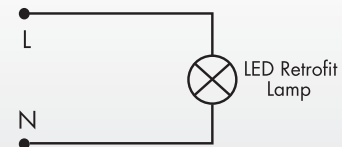

Easy to install - bypass ballast and provide voltage directly to lamp

Accessories (Order as separate line items)

- SP12714 - Surge protector (120-277V)



SPECIALTY LED RETROFIT LAMPS

Directional Mogul Base Lamps

Wattage	Order Code	Base Type	Lumen Output	Color Temperature	CRI	Rated Life (hrs)	Distribution	Power Factor	THD	Model Number
54W	LP27189	E39	6500	5000K	70	50,000	Type V	>0.90	<20%	HR-54T5A2-E39AK-5K
115W	LP38561	E39	13500	5000K	70	50,000	Type V	>0.90	<20%	HR-115T5A2-E39AK-5K

Benefits and Features

- Simple energy saving solution providing significant maintenance savings
- Integrated driver design makes an ideal upgrade from traditional technologies
- Energy saving replacement for MH or HPS
- Up to 5 times longer life and 80% energy savings compared to HID
- 5 year warranty
- Horizontal burn position
- Easy installation
- Reduced maintenance costs
- Perfect for applications such as area lighting and flood lighting



Photometrics

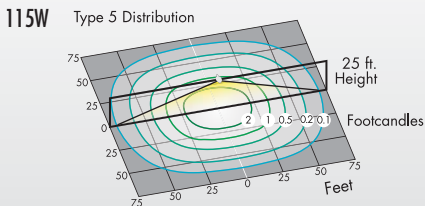
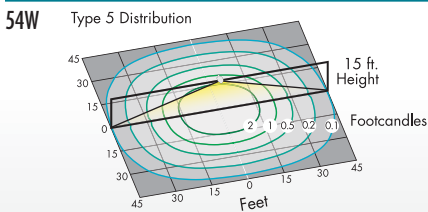

Dimensions

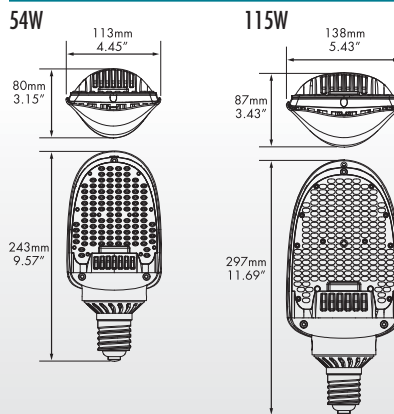

Wiring

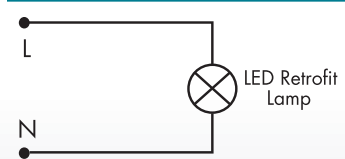

Easy to install - bypass ballast and provide voltage directly to lamp

Accessories (Order as separate line items)

- SP12714 - Surge protector (120-277V)



SPECIALTY LED RETROFIT LAMPS



Lowbay - Mogul Base Retrofit Lamp

Wattage	Order Code	Base Type	Lumen Output	Color Temperature	CRI	Rated Life (hrs)	Power Factor	THD	Model Number
40W	LP27198	EX39	4800	4000K	80	50,000	>0.90	<20%	OR-040AA-EX39-4K



Benefits and Features

- Energy saving replacement for 175W MH or HPS
- Up to 5 times longer life and 80% energy savings compared to HID
- 5 year warranty
- Universal burn position
- Easy installation
- Reduced maintenance costs
- Perfect for applications such as lowbays, canopies, garages, and general illumination

Photometrics

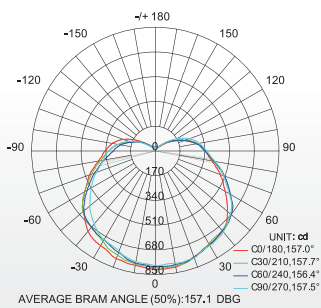

Dimensions

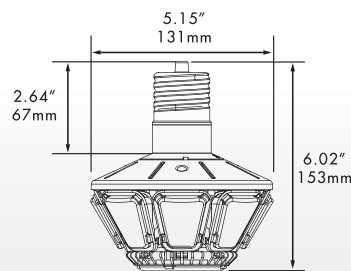

Wiring

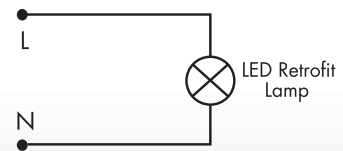

Easy to install - bypass ballast and provide voltage directly to lamp

Accessories (Order as separate line items)

- SP12714 - Surge protector (120-277V)

