



Description

The Venture Lighting LED surface mount canopy series of luminaires are low profile, lightweight and designed for long life and low maintenance. The fixtures are designed to allow for easy replacement of existing canopy lighting fixtures. The robust design paired with universal mounting makes them ideal for locations, such as retail canopies, where heavy pedestrian traffic makes maintenance difficult.

Construction

The housing unit is constructed from heavy-duty aluminum. Fixtures are finished with a durable white polyester powder coating. To ensure weather-tight protection, each optical assembly is sealed with a silicone gasket. Each unit is ETL certified to withstand wet locations. Luminaires are rated for an ambient operating temperature range of -40°C to 40°C.

Optics

High-performance, UV stabilized acrylic optics are used to achieve precise photometric distributions.

Electrical

The Class II power supply has a range of 120-277V, 50/60 Hz. 0-10V dimming capability is standard. Each fixture has a built-in 10kV surge protector.

Mounting

The fixture is designed for universal surface and pendant mounting. IT IS THE CUSTOMER'S RESPONSIBILITY TO VERIFY THE AVAILABILITY OF ADEQUATE SPACE FOR INSTALLATION.

DLC Model# CPA-03C-25NDA-xxAC01

Product Performance

Wattage	23W
Lumen Output	2670
Correlated Color Temperature (CCT)	5000K
Color Rendering Index (CRI)	70+
Lumen Maintenance @50,000 hours*	98%
Calculated L70 @ 25°C Ambient in Hours*	>500,000
Replaces HID Wattage	70W
Operating Temperature Range	-40°F to 104°F (-40°C to 40°C)

Physical Characteristics

Fixture Color	White
Weight	6.8 lbs
Width	12.0"
Length	12.0"
Height	2.4"

Electrical Characteristics

Amperage Draw (Input Volts/Amps)	120/0.21 208/0.12 240/0.10 277/0.09
Surge Protection	10kA

Regulatory Qualifications

cETLus Listed

DLC Qualified - Model# CPA-03C-25NDA-xxAC01

ETL Certified for wet locations when installed under a covered canopy, not an open canopy.

Accessories

SP12714 – 120-277V Surge Protector

Notes:

*Lumen maintenance data is based on LED testing per IESNA LM-80-08 and projected per IESNA TM-21-11



Venture 23W Surface Mount LED Canopy Light

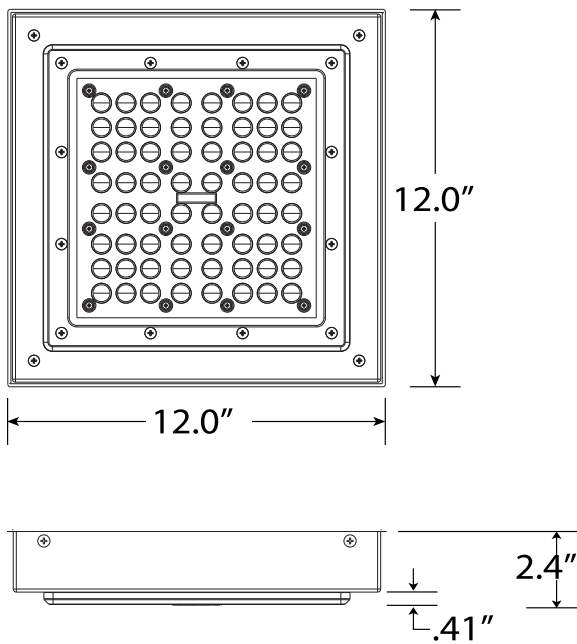

Luminous Intensity Distribution Diagram

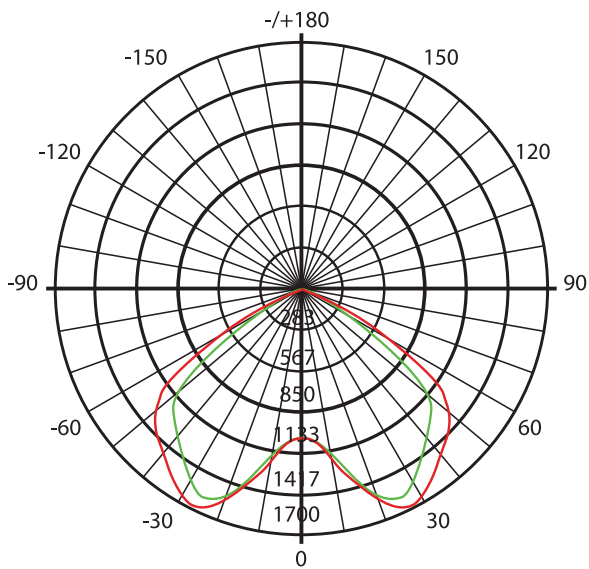

41W Distribution Shown
BUG Rating B1-U0-G0

(800) 451-2606
Fax: (800) 451-2605
2451 Enterprise Parkway East
Twinsburg, Ohio 44087 USA
E-mail: Venture_Lighting@VentureLighting.com
VentureLighting.com

