



Description

CrossCourt LED area lighting fixtures are low profile, low maintenance and feature long life. Perfect for new construction and easy replacement of existing area lighting fixtures. The robust design paired with a variety of mounting options makes them ideal for upgrading existing tennis court lighting fixtures.

Construction

Rugged die cast housing finished in a durable powder coat finish and with vandal resistant polycarbonate lens. To ensure weather-tight protection, each optical assembly is sealed with a silicone gasket. Luminaires are rated for an ambient operating temperature range of -40°C to 40°C.

Electrical

The Class I power supply has a range of 347-480V, 50/60 Hz (a 120-277V input version is also available). LED driver is isolated from the LED light engine for enhanced driver reliability. 0-10V DC dimming capability is standard. The luminaires are rated for wet locations. Each fixture has a built in 10kA surge protector. Each fixture is supplied with a 7-pin receptacle and a shorting cap. A motion sensor can be factory installed. Twistlock photocell accessory can easily be mounted onto the fixture.

Mounting

The fixture is designed for use with various mounting accessories: Square and round pole arms, slipfitter or mast arm. The slipfitter and the mast arm fit a 2-3/8" tenon. All mounting accessories are ordered separately and field installed.

Notes:

*Lumen maintenance data is based on LED testing per IESNA LM-80-08 and projected per IESNA TM-21-11

Product Performance

Wattage	310W
Lumen Output	34000
Correlated Color Temperature (CCT)	5000K
Color Rendering Index (CRI)	70+
Lumen Maintenance @50,000 hours*	89%
Calculated L70 @ 25°C Ambient in Hours*	>162,000
Distribution	Tennis Court Lighting
Replaces HID Wattage	1000W V, 1000W H
Operating Temperature Range	-40°F to 104°F (-40°C to 40°C)

Physical Characteristics

Fixture Color	Bronze
EPA	1.28
Weight	40.0 lbs (18.2kg)
Width	14.17"
BUG Rating	B4-U0-G4
Length	31.50"
Height	7.5"

Electrical Characteristics

Input Voltage Range	347-480V
Amperage Draw (Input Volts/Amps)	347/0.95 480/0.70
Surge Protection	10kA

Regulatory Qualifications

cULus Listed, Rated for wet locations

Accessories

EN14628 Round pole straight arm - bronze - for high watt Environ

EN27395 Square pole mount - bronze - for high watt Environ

EN36717 Adjustable slipfitter - bronze - for high watt Environ

EN38159 Mast arm - bronze - for high watt Environ

PH12415 3-Pin Twist lock photocell (120-277V)

PH81975 Replacement shorting cap

Add suffix "-M12" to order code for a factory installed fixture with Motion/Dim/Photocell Sensor

Add suffix "-SH" to order code for a factory installed fixture with backlight shield

Add suffix "-SHM12" to order code for a factory installed fixture with backlight shield & Motion/Dim/Photocell sensor

SP12714 - 120-277V Surge Protector

PH46224 - Wireless program tool



Venture CrossCourt 310W LED Tennis Lighting

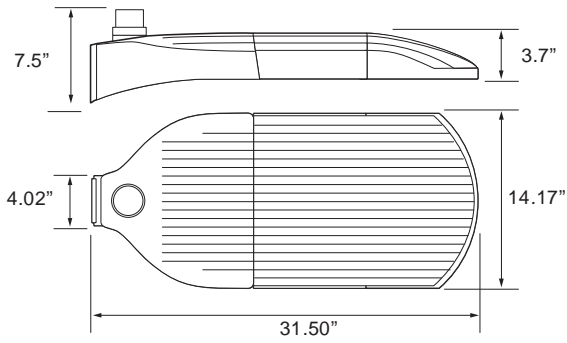

PH12415



EN27395



EN38159



PH81975



EN14628



EN36717

Accessories

(800) 451-2606
Fax: (800) 451-2605
2451 Enterprise Parkway East
Twinsburg, Ohio 44087 USA
E-mail: Venture_Lighting@VentureLighting.com
VentureLighting.com

