



### Description

The Venture Lighting LED Recessed Canopy series of luminaires are low profile, lightweight, and designed for long life and low maintenance. The fixtures are designed to allow for easy replacement of existing recessed lighting fixtures. The robust design paired with universal mounting makes them ideal for locations, such as retail canopies and drive-thrus, where heavy pedestrian or automotive traffic makes maintenance difficult.

### Construction

The housing unit is constructed from heavy-duty aluminum. Fixtures are finished with a durable white polyester powder coating. To ensure weather-tight protection, each optical assembly is sealed with a silicone gasket. Each unit is ETL certified to withstand wet locations for use in covered canopies, not open air canopies. Luminaires are rated for an ambient operating temperature range of -40°C to 40°C.

### Optics

High-performance, UV stabilized acrylic optics are used to achieve precise photometric distributions.

### Electrical

The Class II power supply has a range of 120-277V, 50/60 Hz. The high performance LEDs are rated up to 190,000 hours at 25°C ambient temperature. 0-10V dimming capability is standard.

### Mounting

The fixture is NON-IC Rated and is designed for recessed mounting. IT IS THE CUSTOMER'S RESPONSIBILITY TO VERIFY THE AVAILABILITY OF ADEQUATE SPACE FOR INSTALLATION.

DLC® Model# CPC-03C-25NDA-xxAC01

### Product Performance

Wattage	23W
Lumens	2670
Correlated Color Temperature (CCT)	5000K
Color Rendering Index (CRI)	70+
Lumen Maintenance @50,000 hours*	98%
Calculated L70 @ 25°C Ambient in Hours*	>500,000
Replaces HID Wattage	70W
Operating Temperature Range	-40°F to 104°F (-40°C to 40°C)

### Physical Characteristics

Fixture Color	White
Length	16.0"
Weight	6.8 lbs
Width	16.0"
Height	2.4"

### Electrical Characteristics

Amperage Draw (Input Volts/Amps)	120/0.21 208/0.12 240/0.10 277/0.09
Surge Protection	10kA

### Regulatory Qualifications

cETLus Listed

DLC® Premium Qualified - Model# CPC-03C-25NDA-xxAC01

ETL Certified for wet locations when installed under a covered canopy, not an open canopy.

### Accessories

SP12714 – 120-277V Surge Protector

### Notes:

\*Lumen maintenance data is based on LED testing per IESNA LM-80 and projected per IESNA TM-21



# Venture 23W Recessed LED Canopy Fixture, 5000K

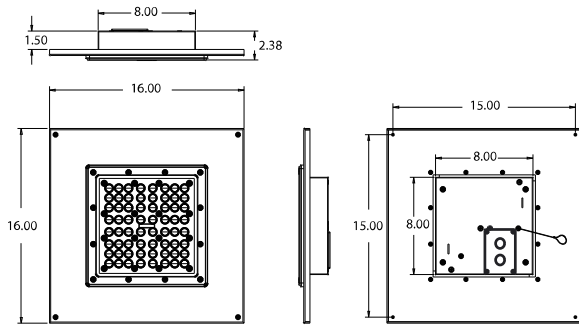

Luminous Intensity Distribution Diagram

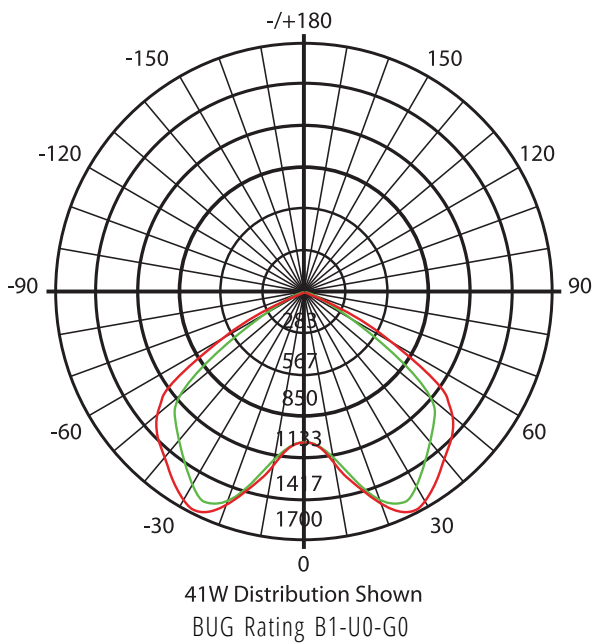

(800) 451-2606  
Fax: (800) 451-2605  
7905 Cochran Rd, Suite 300  
Glenwillow, Ohio 44139  
E-mail: [Venture\\_Lighting@VentureLighting.com](mailto:Venture_Lighting@VentureLighting.com)  
[VentureLighting.com](http://VentureLighting.com)

